

FLUKE®

— Calibration

4180, 4181

Precision Infrared Calibrator

Technical Guide

March 2013

© 2013 Fluke Corporation. All rights reserved. Specifications are subject to change without notice.
All product names are trademarks of their respective companies.

LIMITED WARRANTY AND LIMITATION OF LIABILITY

Each Fluke product is warranted to be free from defects in material and workmanship under normal use and service. The warranty period is one year and begins on the date of shipment. Parts, product repairs, and services are warranted for 90 days. This warranty extends only to the original buyer or end-user customer of a Fluke authorized reseller, and does not apply to fuses, disposable batteries, or to any product which, in Fluke's opinion, has been misused, altered, neglected, contaminated, or damaged by accident or abnormal conditions of operation or handling. Fluke warrants that software will operate substantially in accordance with its functional specifications for 90 days and that it has been properly recorded on non-defective media. Fluke does not warrant that software will be error free or operate without interruption.

Fluke authorized resellers shall extend this warranty on new and unused products to end-user customers only but have no authority to extend a greater or different warranty on behalf of Fluke. Warranty support is available only if product is purchased through a Fluke authorized sales outlet or Buyer has paid the applicable international price. Fluke reserves the right to invoice Buyer for importation costs of repair/replacement parts when product purchased in one country is submitted for repair in another country.

Fluke's warranty obligation is limited, at Fluke's option, to refund of the purchase price, free of charge repair, or replacement of a defective product which is returned to a Fluke authorized service center within the warranty period.

To obtain warranty service, contact your nearest Fluke authorized service center to obtain return authorization information, then send the product to that service center, with a description of the difficulty, postage and insurance prepaid (FOB Destination). Fluke assumes no risk for damage in transit. Following warranty repair, the product will be returned to Buyer, transportation prepaid (FOB Destination). If Fluke determines that failure was caused by neglect, misuse, contamination, alteration, accident, or abnormal condition of operation or handling, including overvoltage failures caused by use outside the product's specified rating, or normal wear and tear of mechanical components, Fluke will provide an estimate of repair costs and obtain authorization before commencing the work. Following repair, the product will be returned to the Buyer transportation prepaid and the Buyer will be billed for the repair and return transportation charges (FOB Shipping Point).

THIS WARRANTY IS BUYER'S SOLE AND EXCLUSIVE REMEDY AND IS IN LIEU OF ALL OTHER WARRANTIES, EXPRESS OR IMPLIED, INCLUDING BUT NOT LIMITED TO ANY IMPLIED WARRANTY OF MERCHANTABILITY OR FITNESS FOR A PARTICULAR PURPOSE. FLUKE SHALL NOT BE LIABLE FOR ANY SPECIAL, INDIRECT, INCIDENTAL, OR CONSEQUENTIAL DAMAGES OR LOSSES, INCLUDING LOSS OF DATA, ARISING FROM ANY CAUSE OR THEORY.

Since some countries or states do not allow limitation of the term of an implied warranty, or exclusion or limitation of incidental or consequential damages, the limitations and exclusions of this warranty may not apply to every buyer. If any provision of this Warranty is held invalid or unenforceable by a court or other decision-maker of competent jurisdiction, such holding will not affect the validity or enforceability of any other provision.

Fluke Corporation
P.O. Box 9090
Everett, WA 98206-9090
U.S.A.

Fluke Europe B.V.
P.O. Box 1186
5602 BD Eindhoven
The Netherlands

11/99

To register your product online, visit register.fluke.com

Table of Contents

1	Before You Start	1
1.1	Introduction	1
1.2	Unpacking.....	1
1.3	Symbols Used.....	2
1.4	Safety Information	3
1.4.1	Warnings	4
1.4.2	Cautions.....	6
1.5	CE Comments	7
1.5.1	EMC Directive	7
1.5.2	Emission Testing.....	7
1.5.3	Low Voltage Directive (Safety)	7
1.6	Authorized Service Centers	7
2	Specifications and Environmental Conditions.....	9
2.1	Specifications.....	9
2.2	Environmental Conditions	9
3	Quick Start.....	11
3.1	Setup.....	11
3.2	Parts and Controls.....	11
3.2.1	Display Panel	11
3.2.2	Display	13
3.2.3	Back Panel	14
3.3	Languages	16
3.3.1	Language Selection	16
3.4	Ice Buildup and Purge Procedure (4180 Only).....	16
3.4.1	Icing Warning	16
3.4.2	Purge Procedure	16
3.4.3	Removing Ice Buildup on the Target.....	17
3.5	Emissivity Setting of the IR Thermometer	17
3.5.1	Apparent Temperature Setting Limits.....	17
3.6	Forced Air and Convection	18
4	Menu Structure.....	19
4.1	Temperature Setup Menu.....	19
4.2	Program Menu.....	20

4.3	System Menu.....	21
4.4	View Temperature Menu.....	22
5	Controller operation.....	23
5.1	Main Screen	23
5.2	Main Menu.....	24
5.2.1	TEMP SETUP.....	24
5.2.2	PROG MENU.....	26
5.2.3	SYSTEM MENU	28
5.2.4	VIEW TEMP	32
6	Basic Infrared Thermometry Theory – Relating to the Use of the 4180 and 4181.....	33
6.1	Apparent Temperature Explanation	33
6.2	Spectral Response (Wavelength)	33
6.3	Emissivity.....	35
6.3.1	Uncertainty Caused by Emissivity.....	35
6.3.2	Effect of Background Temperature	36
6.3.3	Effect of Angle on Emissivity	37
6.4	Calibration Geometry	38
6.4.1	Center of Spot	38
6.4.2	Size of Spot, Size of Source and Scatter	38
6.4.3	Distance to target.....	39
6.4.4	Knowing the Correct Geometry.....	39
6.5	Traceability	39
6.6	Treatment of IR Thermometers	40
6.7	Use of the 4180 and 4181 in the Context of IR Theory	41
6.8	Example of 4180 and 4181 Spectral Emissivity and Calibration Spectral	

Response	42
6.9 Example of an Uncertainty Budget for an IR Thermometer Calibration..	43
6.9.1 Example IR Thermometer Uncertainty Budget	43
6.9.2 Explanations.....	44
6.10 Further Reading	45
7 Digital communication interface.....	47
7.1 Wiring	47
7.1.1 Setup.....	47
7.1.2 Serial Operation	47
7.2 Command Syntax.....	48
7.3 Commands by Function or Group.....	49
7.4 Serial Commands - Alphabetic Listing.....	51
8 Calibration of Your Precision Infrared Calibrator	65
8.1 General.....	65
8.2 Introduction	65
8.3 Terminology	65
8.4 Fundamentals.....	65
8.5 Environmental Conditions	66
8.6 Calibration Equipment.....	66
8.7 Procedure.....	68
8.7.1 Visual Inspection.....	68
8.7.2 Manual IR Target Calibration.....	68
9 Maintenance	77
10 Troubleshooting	79

Tables

Table 1 Symbols used.....	2
Table 2 Specifications.....	9
Table 3 Apparent temperature limits.....	18
Table 4 Commands by Function or Group.....	49
Table 5 Test Equipment Specifications.....	66
Table 6 Chiller Setting per UUT Set-Point.....	71
Table 7 Pre-Test UUT Configuration Settings.....	72
Table 8 Pre-Test Controller/Calibration Constants Settings.....	72
Table 9 Intra-Test Controller Settings.....	73
Table 10 Post-Test UUT Settings.....	73
Table 11 IR target Testing Sequence.....	74
Table 12 4180 Radiometric Accuracy Test Settings and Specs - Model 4180	74
Table 13 Radiometric Accuracy Test Settings and Specs – Model 4181.....	74
Table 14 IR target Accuracy Adjustment Specifications.....	76
Table 15 Troubleshooting, problems, causes and solutions.....	79

Figures

Figure 1 Display panel.....	12
Figure 2 Main screen	14
Figure 3 418X back panel.....	15
Figure 4 Steps to language selection	16
Figure 5 Temperature setup menu.....	19
Figure 6 Program menu	20
Figure 7 System menu	21
Figure 8 View temp menu	22
Figure 9 Relation between Planck's Law and Wien's Displacement Law	35
Figure 10 Effect of a 1% increase in emissivity in the 8-14 μ m band	36
Figure 11 Effect of a 1% increase in background temperature in the 8-14 μ m band	37
Figure 12 Effect of Angular Emissivity	38
Figure 13 418X Traceability	40
Figure 14 Typical results of FTIR testing on the 418X surface coating.....	42
Figure 15 Spectral Response of IR thermometer used to calibrate the 418X.	43
Figure 16 RS-232 wiring	48
Figure 17 Flow chart for manual calibration	67
Figure 18 4180 and 4181 Calibration Model	70

1 Before You Start

1.1 Introduction

The Model 4180/4181 Portable IR Calibrator may be used as a portable instrument or bench top temperature calibrator for calibrating point IR thermometers. The 4180/4181 is small enough to use in the field, and accurate enough to use in the lab.

The instruments feature:

- Rapid heating and cooling
- RS-232 interface capability

Built in programmable features include:

- Temperature scan rate control
- Eight set-point memory
- Adjustable readout in °C or °F
- Adjustable Emissivity

The temperature is accurately controlled by Hart's digital controller. The controller uses a precision platinum RTD as a sensor and controls the surface temperature with a solid state relay (triac) driven heater (4181) and FET driven Peltier modules (4180).

The LCD display continuously shows the current temperature. The temperature may be easily set with the control buttons to any desired temperature within the specified range. The instrument's multiple fault protection devices insure user and instrument safety and protection.

The 4180/4181 calibrators are designed for portability and ease of operation. Through proper use the instrument will provide continued accurate calibration of IR temperature measurement devices. The user should be familiar with the safety guidelines and operating procedures of the calibrator as described in this User's Guide.

Unique patent pending safety features make the instruments the safest IR calibrators available. The Block Temperature Indicator (Patent Pending) shows the user when the target temperature is above 50°C letting the user know when it is safe to place the target cover on the instrument and/or move it to a different location. The indicator remains illuminated when the instrument is energized and above 50°C, but with mains power removed, it will flash until the target temperature drops below 50°C.

1.2 Unpacking

Unpack the calibrator carefully and inspect it for any damage that may have occurred during shipment. If there is shipping damage, notify the carrier immediately.

Verify that the following components are present:

4180, 4181 Precision Infrared Calibrator

Symbols Used

4180

- 4180 IR Calibrator
- Report of Calibration
- Power Cord
- User's Guide
- Documentation CD
- Target Cover
- Serial Cable

4181





- 4181 IR Calibrator
- Report of Calibration
- Power Cord
- User's Guide
- Documentation CD
- Serial Cable











If all items are not present, contact an Authorized Service Center (see Section 1.6 Authorized Service Centers on page 7).

1.3 Symbols Used

Table 1 lists the International Electrical Symbols. Some or all of these symbols may be used on the instrument or in this guide.

Table 1 Symbols used

Symbol	Description
	AC (Alternating Current)
	AC-DC
	Battery
	Complies with European Union directives
	DC

Symbol	Description
	Double Insulated
	Electric Shock
	Fuse
	PE Ground
	Hot Surface (Burn Hazard)
	Read the User's Guide (Important Information)
	Off
	On
	Canadian Standards Association
	C-TICK Australian EMC mark
	The European Waste Electrical and Electronic Equipment (WEEE) Directive (2002/96/EC) mark.

1.4 Safety Information

The Portable IR Calibrators are designed in accordance with IEC 61010-1, IEC 61010-2-010 and CAN/CSA 22.2 No 61010.1-04. Use this instrument only as specified in this manual. Otherwise, the protection provided by the instrument may be impaired.

The following definitions apply to the terms “Warning” and “Caution”.

- “Warning” identifies conditions and actions that may pose hazards to the user.
- “Caution” identifies conditions and actions that may damage the instrument being used.

1.4.1 Warnings

To avoid personal injury, follow these guidelines.

General

DO NOT use this instrument for any application other than calibration work. The instrument was designed for temperature calibration. Any other use of the instrument may cause unknown hazards to the user.

This instrument is intended for indoor use only.

Follow all safety guidelines listed in the User's Guide.

Calibration Equipment should only be used by Trained Personnel.

If this equipment is used in a manner not specified by the manufacturer, the protection provided by the equipment may be impaired.

Before initial use, or after transport, or after storage in humid or semi-humid environments, or anytime the instrument has not been energized for more than 10 days, the instrument needs to be energized for a "dry-out" period of 2 hours before it can be assumed to meet all of the safety requirements of the IEC 61010-1. If the product is wet or has been in a wet environment, take necessary measures to remove moisture prior to applying power such as storage in a low humidity temperature chamber operating at 50°C for 4 hours or more.

Overhead clearance is required for the 4181. At least 1 meter (39 inches) overhead clearance is recommended. **DO NOT** place the instrument under a cabinet or other structure. Allow at least 15 cm (6 inches) of clearance around the instrument.

DO NOT face the target towards a wall or other object. The target emits high amounts of heat and will cause objects to heat up or catch fire.

DO NOT use this instrument in environments other than those listed in the User's Guide.

DO NOT operate near flammable materials.

Use of this instrument at **HIGH TEMPERATURES** for extended periods of time requires caution.

Completely unattended high temperature operation is not recommended due to safety hazards that can arise.

Do not use the instrument if it operates abnormally. Protection may be impaired. When in doubt, have the instrument serviced.

Burn Hazard

DO NOT touch the IR target surface or areas surrounding the target of the instrument. If the instrument is set at 100°C, the display reads 100°C, the target surface may be 100°C or greater. The sheet metal of the instrument may exhibit extreme temperatures for areas close to the IR target surface.

This instrument is equipped with a Block Temperature Indicator (front panel LED HOT indicator – Patent Pending). When the indicator is flashing, the instrument is disconnected from mains power and the temperature of the block is above 50°C. When the indicator is illuminated, always on, the instrument is powered and the block temperature is above 50°C.

Temperatures above 70°C (158°F) are considered hazardous. Use extreme care when working with these temperatures. Observe all warnings and cautions given in this manual.

DO NOT turn off the instrument at temperatures higher than 100°C. This could create a hazardous situation. Select a set-point less than 100°C and allow the instrument to cool before turning it off.

DO NOT operate instrument in any orientation other than vertical (target face perpendicular to installation surface). Risk of fire or burn hazard may result due to excessive heat buildup.

The instrument can generate extreme temperatures. Precautions must be taken to prevent personal injury or damage to objects.

The air around the instrument can reach temperatures greater than 100°C.

The high temperatures present in instruments designed to operate at 300°C and higher may result in fires and severe burns if safety precautions are not observed.

Electrical Hazard

These guidelines must be followed to ensure that the safety mechanisms in this instrument will operate properly. This instrument must be plugged into an AC only outlet according to Section 2.1 Specifications on page 9. The power cord of the instrument is equipped with a three-pronged grounding plug for your protection against electrical shock hazards. It must be plugged directly into a properly grounded three-prong receptacle. The receptacle must be installed in accordance with local codes and ordinances. Consult a qualified electrician.

DO NOT use an extension cord or adapter plug.

DO NOT operate this instrument without a properly grounded, properly polarized power cord.

DO NOT connect the instrument to a non-grounded outlet.

For installations with polarized outlets, insure that the polarity of the connection is correct.

HIGH VOLTAGE is used in the operation of this equipment. Contact an Authorized Service Center (see Section 1.6 Authorized Service Centers on page 7) for obtaining service from a qualified technician. No user serviceable parts.

If supplied with user accessible fuses, always replace the fuse with one of the same rating, voltage, and type.

Always replace the power cord with an approved cord of the correct rating and type.

1.4.2 Cautions

Protect the target against dirt and damage – scrapes and scratches. A well kept target surface, free from dirt and damage, produces better measurements. Use the target cover whenever the instrument is not in use to protect the target. Always use the target cover when transporting the instrument, but remember to never transport the instrument when the target temperature is above 50°C.

DO NOT touch the target. Oils and salts from the skin will permanently damage the target surface at high temperatures.

When ice forms on the target, change the instrument set-point higher than 50°C to melt the excess ice. **DO NOT** wipe the front plate (target). Change the set-point to 100°C or higher to evaporate the excess water.

DO NOT use fluids to clean the target surface.

DO NOT use shop air to clean the target surface. Oil and contaminants in the shop air could contaminate the surface.

DO NOT use canned, compressed air (used to clean a computer) to clean the target surface. Chemicals in the air could contaminate the target surface.

DO NOT force cool the surface. The surface should not be cooled by any method other than natural convection. Forced air can often have oil or water in it. Even water can leave mineral deposits on the surface. Trying to cool the surface too quickly can also cause thermal shock to the emissive surface.

DO NOT use liquid nitrogen (LN2) to quick cool the target.

DO NOT plug the instrument into 230V if the fuse holder reads 115V. This action will cause the fuses to blow and may damage the instrument.

Component lifetime can be shortened by continuous high temperature operation.

DO NOT change the values of the calibration constants from the factory set values. Calibration constants shall only be changed by qualified and authorized personnel. The correct setting of these parameters is important to the safety and proper operation of the calibrator.

DO use a ground fault interrupt device.

Always operate this instrument at room temperatures as stated in Section 2.2 Environmental Conditions on page 9.

The instrument is a precision instrument. Although it has been designed for optimum durability and trouble free operation, it must be handled with care. It is important to keep the calibration well and the IR target surface clean and clear of any foreign matter.

Always carry the instrument in an upright position. The convenient pull-up handle allows one hand carrying.

DO NOT operate the instrument in excessively wet, oily, dusty, or dirty environments.

DO NOT operate near flammable materials.

If a main supply power fluctuation occurs, immediately turn off the instrument. Wait until the power has stabilized before re-energizing the instrument.

Use the target cover at temperatures below ambient (25°C). If ice or liquid water forms on the target, IR thermometers will not indicate the correct temperature.

1.5 CE Comments

1.5.1 EMC Directive

Hart's equipment has been tested to meet the European Electromagnetic Compatibility Directive (EMC Directive, 89/336/EEC). The Declaration of Conformity for your instrument lists the specific standards to which the instrument was tested.

The instrument was designed specifically as a test and measuring device. Compliance to the EMC directive is through IEC 61326-1 Electrical equipment for measurement, control and laboratory use.

As noted in the IEC 61326-1, the instrument can have varying configurations. The instrument was tested in a typical configuration with shielded RS-232 cables.

1.5.2 Emission Testing

The instrument fulfills the limit requirements for Class A equipment. The instrument was not designed to be used in domestic establishments.

1.5.3 Low Voltage Directive (Safety)

In order to comply with the European Low Voltage Directive (2006/95/EC), Hart's equipment has been designed to meet the EN 61010-1 and EN 61010-2-010 standards.

1.6 Authorized Service Centers

Please contact one of the following Authorized Service Centers to coordinate service on your Hart product:

Fluke Corporation Hart Scientific Division

799 E. Utah Valley Drive
American Fork, UT 84003-9775
USA

Phone: +1.801.763.1600
Telefax: +1.801.763.1010
E-mail: support@hartscientific.com

4180, 4181 Precision Infrared Calibrator

Authorized Service Centers

Fluke Nederland B.V.

Customer Support Services
Science Park Eindhoven 5108
5692 EC Son
NETHERLANDS

Phone: +31-402-675300
Telefax: +31-402-675321
E-mail: ServiceDesk@fluke.nl

Fluke Int'l Corporation

Service Center - Instrimpex
Room 2301 Sciteck Tower
22 Jianguomenwai Dajie
Chao Yang District
Beijing 100004, PRC
CHINA

Phone: +86-10-6-512-3436
Telefax: +86-10-6-512-3437
E-mail: xingye.han@fluke.com.cn

Fluke South East Asia Pte Ltd.

Fluke ASEAN Regional Office
Service Center
60 Alexandra Terrace #03-16
The Comtech (Lobby D)
118502
SINGAPORE

Phone: +65-6799-5588
Telefax: +65-6799-5589
E-mail: anthony.ng@fluke.com

When contacting a Service Centers for support, please have the following information available:

- Model Number
- Serial Number
- Voltage
- Complete description of the problem

2 Specifications and Environmental Conditions

2.1 Specifications

Table 2 Specifications

	4180	4181
Temperature range (@ 23 °C ambient, 0.95 emissivity)	-15 °C to 120 °C	35 °C to 500 °C
Display accuracy¹	± 0.40 °C at -15 °C ± 0.40 °C at 0 °C ± 0.50 °C at 50 °C ± 0.50 °C at 100 °C ± 0.55 °C at 120 °C	± 0.35 °C at 35 °C ± 0.50 °C at 100 °C ± 0.70 °C at 200 °C ± 1.20 °C at 350 °C ± 1.60 °C at 500 °C
Stability	± 0.10 °C at -15 °C ± 0.05 °C at 0 °C ± 0.10 °C at 120 °C	± 0.05 °C at 35 °C ± 0.20 °C at 200 °C ± 0.40 °C at 500 °C
Uniformity³ (5.0 in dia of center of target)	± 0.15 °C at -15 °C ± 0.10 °C at 0 °C ± 0.25 °C at 120 °C	± 0.10 °C at 35 °C ± 0.50 °C at 200 °C ± 1.00 °C at 500 °C
Uniformity³ (2.0 in dia of center of target)	± 0.10 °C at -15 °C ± 0.10 °C at 0 °C ± 0.20 °C at 120 °C	± 0.10 °C at 35 °C ± 0.25 °C at 200 °C ± 0.50 °C at 500 °C
Heating time	15 min: -15 °C to 120 °C 14 min: 23 °C to 120 °C	20 min: 35 °C to 500 °C
Cooling time	15 min: 120 °C to 23 °C 20 min: 23 °C to -15 °C	100 min: 500 °C to 35 °C 40 min: 500 °C to 100 °C
Stabilization time	10 minutes	10 minutes
Nominal emissivity³	0.95	0.95
Thermometer emissivity compensation	0.9 to 1.0	
Target diameter	152.4 mm (6 in)	
Computer interface	RS-232	
Power	115 V ac (± 10%), 6.3 A, 50/60 Hz, 630 W 230 V ac (± 10%), 3.15 A, 50/60 Hz, 630 W	115 V ac (± 10%), 10 A, 50/60 Hz, 1000 W 230 V a (± 10%), 5 A, 50/60 Hz, 1000 W
Fuse(s)	115 V ac 6.3 A, 250 V, slow blow 230 V ac 3.15 A, 250 V, T	115 V ac 10 A, 250 V, fast blow 230 V ac 5 A, 250 V, F
Size (HxWxD)	356 mm x 241 mm x 216 mm (14 in x 9.5 in x 8.5 in)	356 mm x 241 mm x 216 mm (14 in x 9.5 in x 8.5 in)
Weight	9.1 kg (20 lb)	9.5 kg (21 lb)
Safety	EN 61010-1:2001, CAN/CSA C22.2 No. 61010.1-04	

¹For 8 μm to 14 μm spectral band thermometers with emissivity set between 0.9 and 1.0

²The uniformity specification refers to how IR thermometers with different spot sizes both focused at the center of the target will measure the same temperature.

³The target has a nominal emissivity of 0.95, however it is radiometrically calibrated to minimize emissivity related uncertainties.

2.2 Environmental Conditions

Although the instrument has been designed for optimum durability and trouble-free operation, it must be handled with care. The instrument should not be operated in an

4180, 4181 Precision Infrared Calibrator

Environmental Conditions

excessively dusty or dirty environment. Maintenance and cleaning recommendations can be found in the Maintenance section of this manual.

The instrument operates safely under the following conditions:

- ambient temperature range: 5-35°C (41-95°F)
- ambient relative humidity: maximum 80% for temperature <31°C, decreasing linearly to 50% at 40°C
- mains voltage within $\pm 10\%$ of nominal
- vibrations in the calibration environment should be minimized
- altitudes less than 2,000 meters
- indoor use only

3 Quick Start

3.1 Setup



Note: The instrument will not heat, cool, or control until the "SET PT." parameter is "Enabled".

Place the instrument on a flat surface with at least 15 cm (6 inches) of free space around the instrument. Overhead clearance is required. DO NOT place under a cabinet or structure.

Plug the power cord of the instrument into a mains outlet of the proper voltage, frequency, and current capability (see Section 2.1 Specifications on page 9 for power details). Observe that the nominal voltage corresponds to that indicated on the power entry model at the back of the calibrator.

Turn on the power to the calibrator by toggling the switch on the power entry module. After a brief self-test, the controller should begin normal operation. The main screen will appear within 30 seconds. If the instrument fails to operate, please check the power connection. The display will show the well temperature, and wait for user input before further operation.

Press "SET PT." and use the arrow keys to set the desired set-point temperature. Press "ENTER" to save the desired set-point and enable the IR Calibrator. After five (5) seconds the instrument should start to operate normally and heat or cool to the designated set-point.

3.2 Parts and Controls

This section describes the exterior features of the IR Calibrator. All interface buttons are found on the front of the IR Calibrator (Figure 1 on next page). Power connection and serial connections are found on the back of the instrument (see Figure 3 on page 15).

3.2.1 Display Panel

Display (1)

The display is a 240 x 160 pixel monochrome graphics LCD device with a bright LED backlight. The display is used to show current control temperature, measurements, status information, operating parameters, and soft key functions.

SET PT. (2)

The SET PT. Key allows you to enable the instrument to heat or cool to a desired set-point. Until this key is enabled, the instrument will not heat or cool. It is in a "sleep" state for safety of the operator and instrument.

4180, 4181 Precision Infrared Calibrator

Parts and Controls

°C/°F Key (3)

The °C/°F Key allows you to change the displayed temperature units from °C to °F and vice versa.

Menu Key (4)

The MENU key allows the user to access all parameter and settings menus. From the main menu, the user can use the soft keys to access submenus and functions.

Exit Key (5)

The EXIT key allows you to exit menus and cancel newly entered values.

Arrow Keys (6)

The arrow keys allow you to move the cursor on the display, change the display layout, and adjust the contrast of the display.

Enter Key (7)

The ENTER key allows you to select menus and accept new values.

Soft Keys (8)

The soft keys are the four buttons immediately below the display (labeled F1 to F4). The functions of the soft keys are indicated on the display above the buttons. The function of the keys may change depending on the menu or function that is selected.

Block Temperature Indicator (9) [Patent Pending]

The block temperature indicator allows users to know when it is safe (50°C to 60°C) to install the target cover. The indicator illuminates when the target exceeds approximately 50°C. The indicator illuminates until the target cools to less than approximately 50°C. If the instrument is disconnected from mains power, the indicator flashes until the target temperature is less than approximately 50°C.

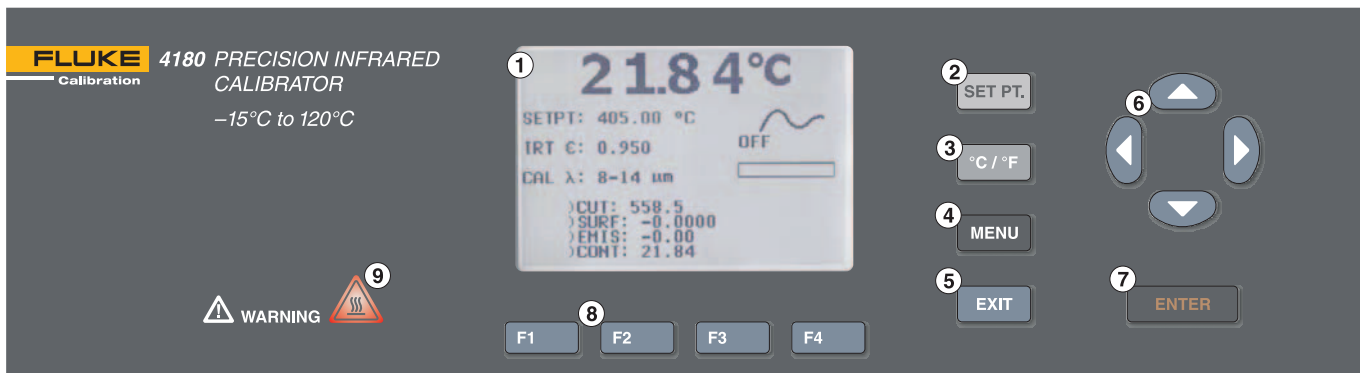

Figure 1 Display panel

3.2.2 Display

The front panel display is shown in detail in Figure 2 on next page.

Process Temperature (1)

The most recent block temperature measurement is shown in large digits in the box at the top of the screen.

Set-Point Temperature (2)

The current set-point temperature is displayed just below the Process Temperature.

Emissivity Setting (IRT ϵ) (3)

The current infrared thermometer emissivity setting is displayed below the current set-point temperature.

Calibration Wavelength (CAL λ) (4)

The current calibration wavelength selected. The wavelength band at which the instrument was calibrated.

Stability Status (5)

On the right hand side of the screen, a graph displays the current status of the stability of the IR Calibrator.

Heating/Cooling Status (6)

Just below the stability graph, a bar graph indicates HEATING, COOLING, or CUT-OUT. This status graph indicates the current level of heating or cooling if the instrument is not in cutout mode.

Soft Key Functions (7) (not shown)

The four sets of text at the bottom of the display indicate the functions of the soft keys (F1–F4). These functions change with each menu.

Editing Windows

While setting up and operating the instrument, you are often required to enter or select parameters. Editing windows appear on the screen when necessary to show the values of parameters and allow edits.

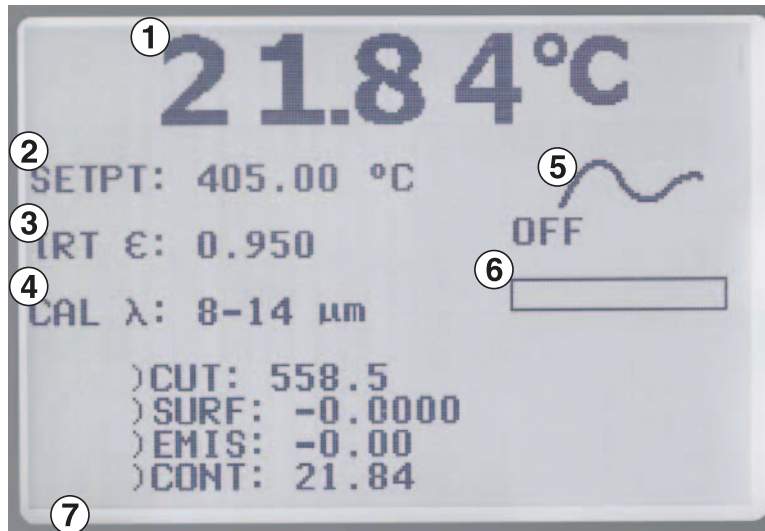

Figure 2 Main screen

3.2.3 Back Panel

The following are found on the back panel of the IR Calibrator (see Figure 3 on opposite page).

Fan (1)

The fan is located high in the center of the back of the instrument. Do not obstruct the airflow of the fan. Leave at least 6 inches of air flow around the instrument.

Power Entry Module (2)

The power supply cord attaches to the power entry module. Plug the cord into an AC mains supply appropriate for the voltage displayed on the power entry module and as specified in Section 2.1 Specifications on page 9.

Power Cord

The power entry module contains the attachment for the power supply cord to the right hand side back panel. Plug the cord into an AC mains supply appropriate for the voltage range as specified in the specifications tables.

Power Switch

The power switch is located on the power entry module of the instrument.

Fuses

The 418X fuses are located inside the power entry module of the instrument (Figure 3 on opposite page).

If necessary, fuses must be replaced according to Section 2.1 Specifications on page 9.

Serial Connector (3)

The serial (RS-232) interface can be used to transmit measurements and control the operation of the IR Calibrator.

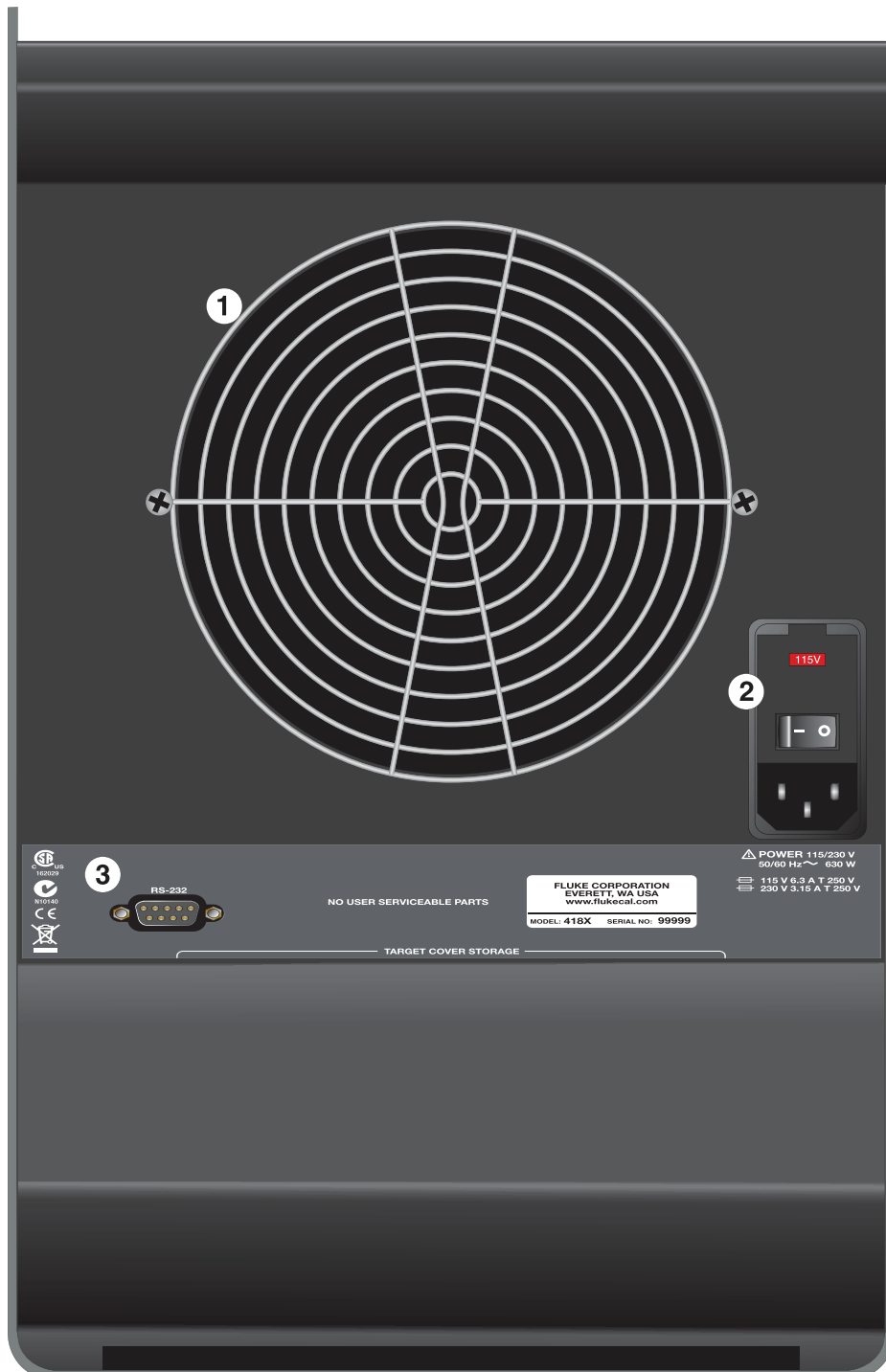

Figure 3 418X back panel

3.3 Languages

The display on the instrument can be set to different languages depending on the configuration.

- European: English, French, Spanish, Italian, German, Chinese, Japanese
- Russian: Russian, English

3.3.1 Language Selection

The languages are located in the Menu system under the System Menu/Display Setup. Select the language to be displayed by using the left and right arrow keys (see Section 4.3 System Menu on page 21).

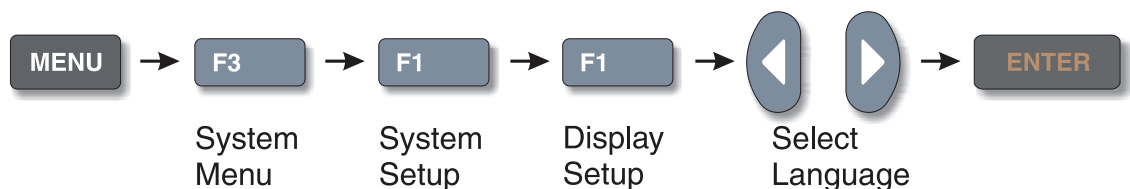

Figure 4 Steps to language selection

3.3.1.1 Reset to English Language

F1 + F4 temporarily displays English, or returns to the selected language. The selected language will resume after the power is switched off and on again. To permanently select English, follow the instructions listed in Section 3.3.1 Language Selection.

3.4 Ice Buildup and Purge Procedure (4180 Only)

3.4.1 Icing Warning

At the factory, the instrument calibration is done with the target free of any ice or moisture. Ice or moisture on the target changes the target's emissivity and apparent temperature. If there is any ice or moisture (even though it is a slight amount) on the target, the display temperature accuracy is invalid. In addition, ice buildup can damage the surface coating causing the radiometric calibration to drift.

The user of the IR Precision Calibrator should always avoid ice buildup. To facilitate this, a cover with a purge inlet is provided with the 4180. It is recommended that the target cover be used at any set-point below the dew point. Depending on the ambient humidity of the environment where the target is used, the dew point can be as high as the ambient temperature of that environment.

3.4.2 Purge Procedure

Use of the cover allows the target to be used at temperatures below the dew point. The target is less likely to form ice while the target is covered. The target cover is provided with a purge inlet to further prevent ice buildup. To use the purge, the user will need a 6mm (0.25 in) outside diameter tube. Connect tubing to the purge inlet on the target

cover. You must use a dry gas for the purge. This means the gas should have a dew point below -15°C . We recommend nitrogen or dried air. If the gas contains any water vapor, ice or moisture will form on the target. A relatively low flow rate of 2.4 – 4.8 liters/min (5 – 10 CFH) is recommended for the purge.

Do not leave the target uncovered for more than 5 seconds, since it can cause ice to form on the target. To make measurements below the dew point, do the following:

1. Put the target cover in place.
2. Adjust the set-point to the desired temperature and allow the instrument to stabilize at that temperature.
3. Remove the target cover when the target stabilizes.
4. Take a sample
5. Replace the target cover.

3.4.3 Removing Ice Buildup on the Target

If a small amount of ice has formed, you can place the cover back on the target and allow the purge gas to sublime the ice. If there is more ice or you don't have a purge available, change the instrument set-point to a temperature equal to or greater than 50°C with the target uncovered. Allow all ice to melt and all water to dry before re-turning target to use. **DO NOT** wipe the target.

3.5 Emissivity Setting of the IR Thermometer

The 4180 and 4181 Precision IR Calibrators are calibrated with a radiometric calibration. This calibration is done with a highly accurate IR thermometer. This IR thermometer has an emissivity setting of 0.950 during the 4180 or 4181 calibration. Therefore, when calibrating IR thermometers using the 4180 or 4181, it is best practice to use an IR thermometer emissivity setting of 0.950. Some IR thermometers do not have an adjustable emissivity setting. Most of these will have emissivity set as 0.95. In either of these cases, the apparent emissivity setting of the instrument should also be set to 0.95.

If the IR thermometer being used does not have an emissivity setting of 0.95, the 4180 and 4181 allows adjustment of emissivity (IRT ϵ , from 0.90 to 1.00). Refer to Section 4Menu Structure on page 19 for information on how to access IRT ϵ in the controller menu.

If you are not certain of the emissivity setting of the IR thermometer you are calibrating, consult your IR thermometer's User's Guide or your IR thermometer's manufacturer.

3.5.1 Apparent Temperature Setting Limits

The IR calibrator is calibrated with an emissivity setting of 0.95. The instruments have a variable emissivity adjustment that allows the user to vary their apparent emissivity from 0.90 to 1.00. This setting should match the IR thermometer's emissivity setting. It is best to use the emissivity setting of 0.95. However, some IR thermometers do not allow for an emissivity setting of 0.95. For these instruments, the calibrator's emissivity setting should be set to the IR thermometer's emissivity setting. Due to safety issues

4180, 4181 Precision Infrared Calibrator

Forced Air and Convection

and the physical limits of the instrument, the temperature range of the instrument may be limited from the specified range when using an emissivity setting other than 0.95. A table of this limitation is shown in Table 3.

Table 3 Apparent temperature limits

ϵ	4180		4181	
	HI (°C)	LO (°C)	HI (°C)	LO (°C)
0.90	120.0	-15.0	500.0	35.0
0.91	120.0	-15.0	500.0	35.0
0.92	120.0	-15.0	500.0	35.0
0.93	120.0	-15.0	500.0	35.0
0.94	120.0	-15.0	500.0	35.0
0.95	120.0	-15.0	500.0	35.0
0.96	119.2	-14.5	496.6	35.0
0.97	118.4	-14.0	493.2	35.0
0.98	117.6	-13.5	489.8	35.0
0.99	116.8	-13.0	486.4	35.0
1.00	116.0	-12.5	483.0	35.0

3.6 Forced Air and Convection

Since the 4180 and 4181 have a large surface area, a major component of the temperature uncertainty is caused by changes in convection. Because of this, the user should keep the instrument away from areas with large amounts of air flow or drafts.

4 Menu Structure

4.1 Temperature Setup Menu

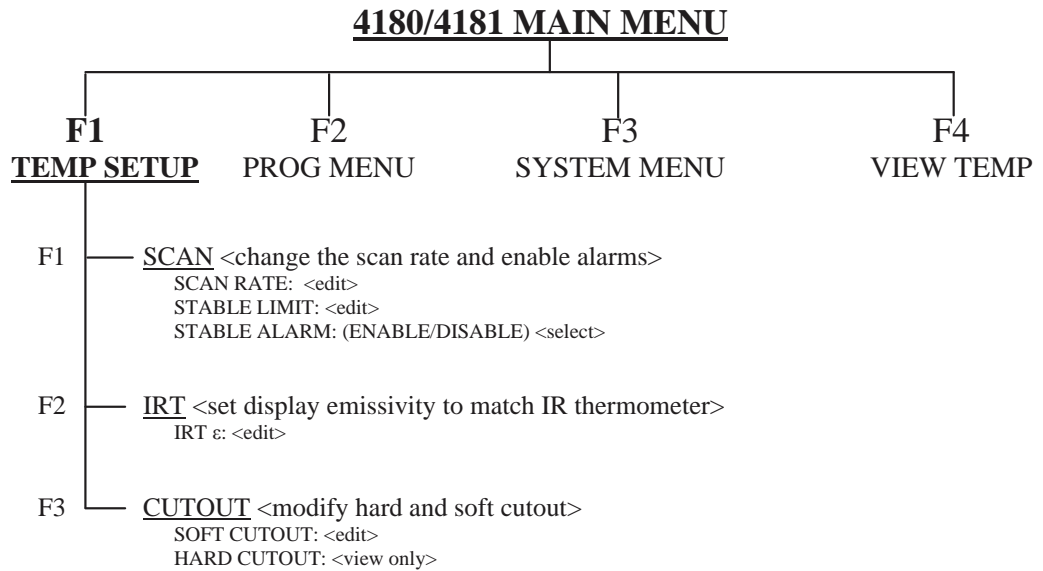

Hot Keys

SETPoint Key - **SET TEMPERATURE SETPOINT**
 SETPOINT: <set point temperature> <edit>
 ENTER <enable control of the instrument>
 F1 - SELECT PRESET <1-8> <select>
 F1 - EDIT PRESET <1-8> <edit>
 F4 - SAVE/DISABLE <disables control of the instrument>

°C / °F Key - Units: <°C, °F>

Up/ Down Arrow Keys <contrast adjust> <toggle>
 Up Key: Lighter
 Down Key: Darker

F1 & F4 Keys (same time) <reset to English language>

F1 & F3 Keys (same time) <turn off key press beep>

Figure 5 Temperature setup menu

4.2 Program Menu

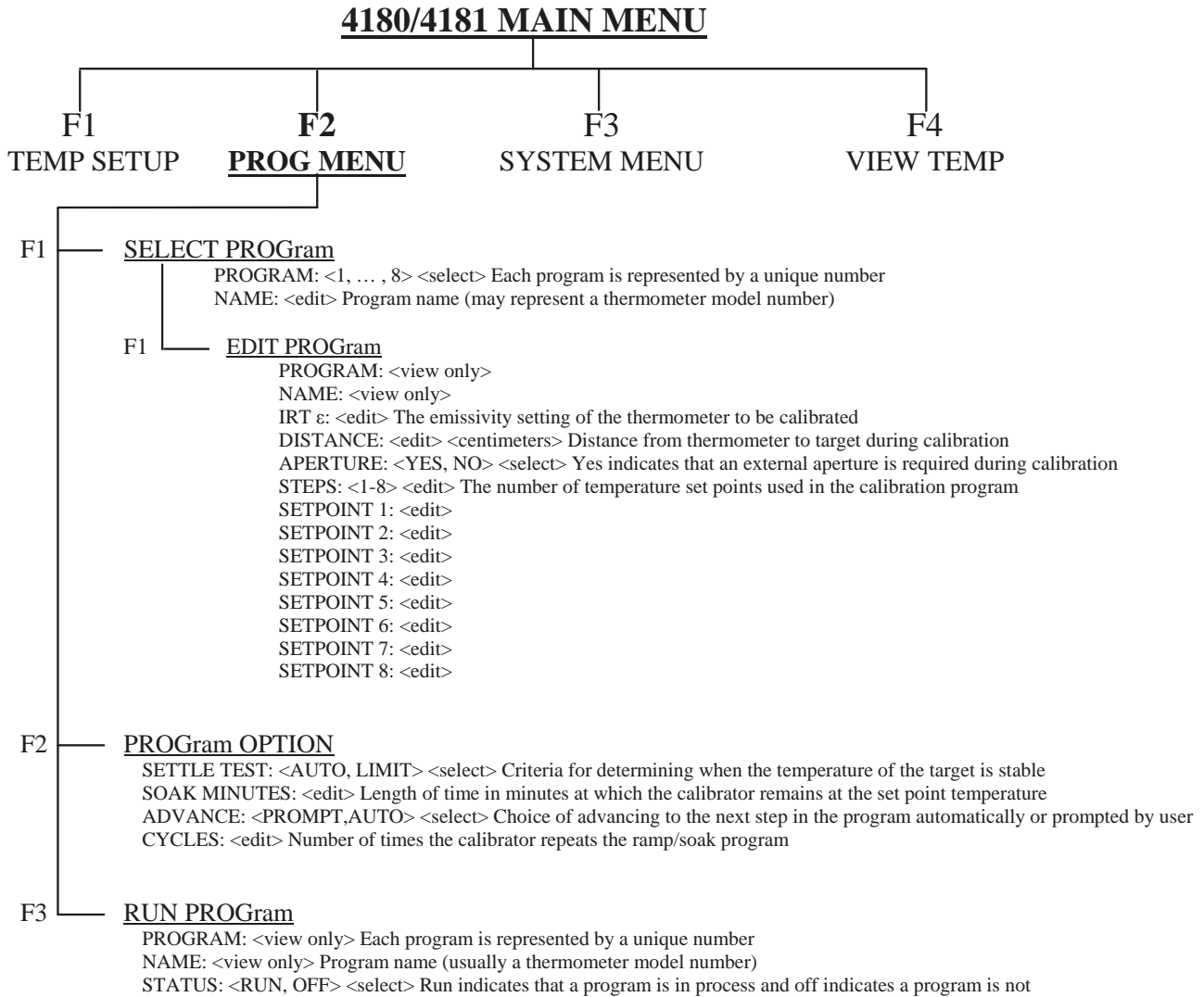

Figure 6 Program menu

4.3 System Menu

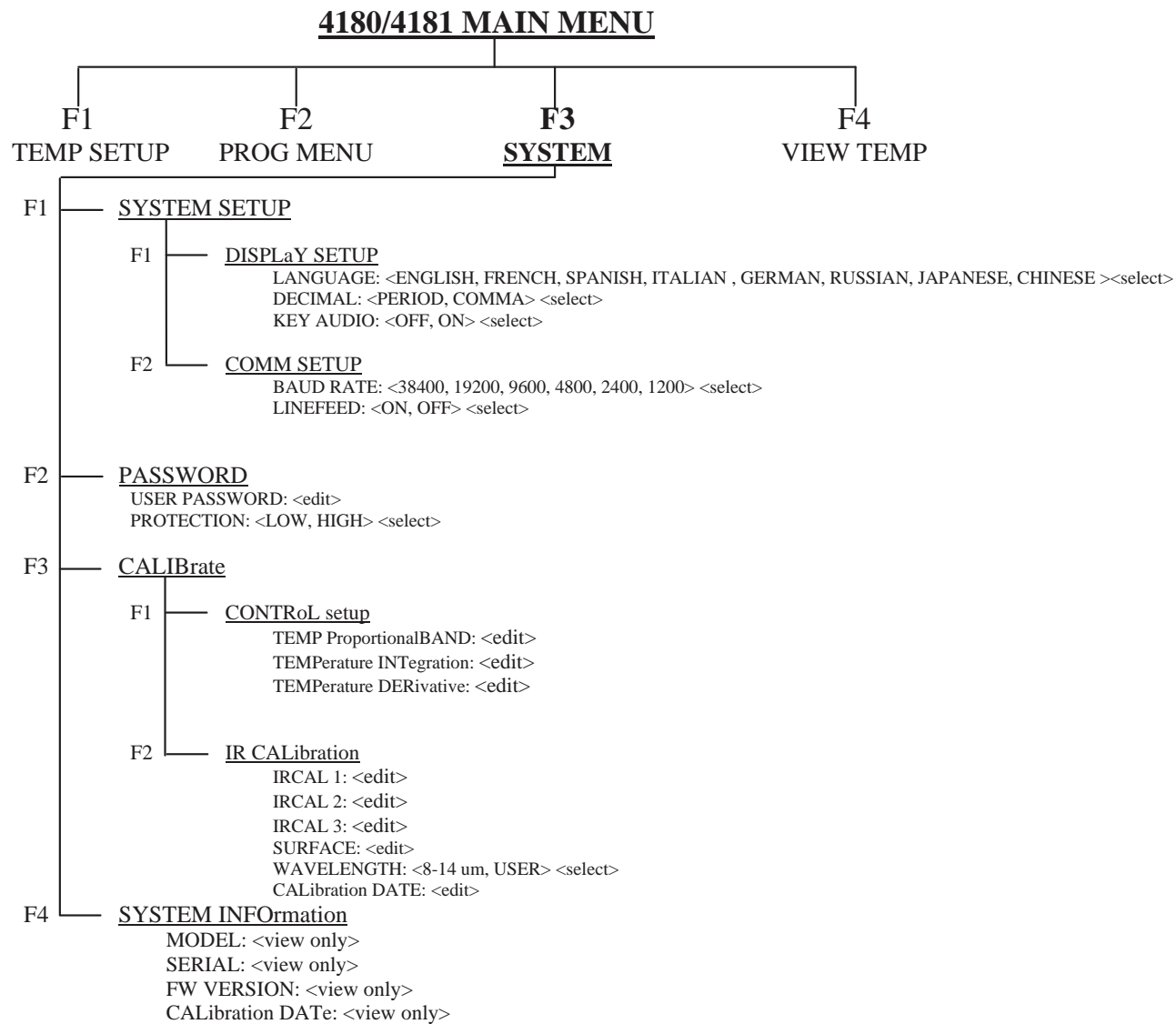

Figure 7 System menu

4.4 View Temperature Menu

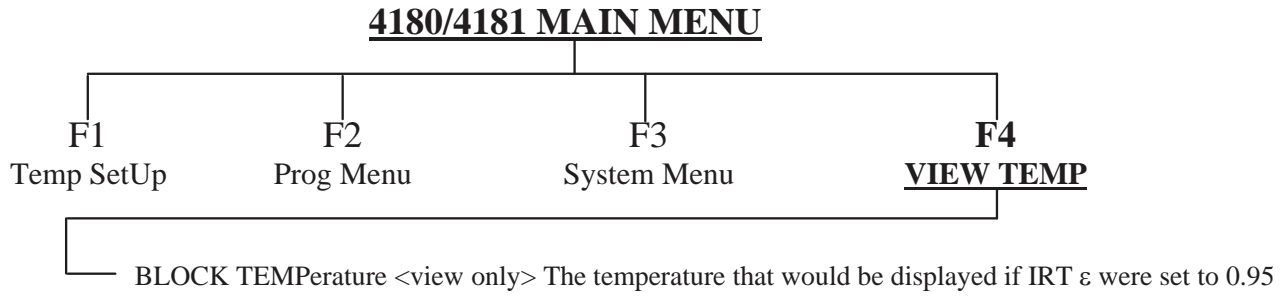

Figure 8 View temp menu

5 Controller operation

This chapter discusses in detail how to operate the Precision Infrared Calibrator temperature controller using the front control panel. Using the front panel keys and liquid crystal display (LCD) the user may monitor the target temperature, set the temperature set-point in °C or °F, monitor the heater output power, monitor the stability, set the cutout set-point, set the operating parameters, and configure the communication interface. A diagram of the full menu structure can be found at the end of this section. When active, menu keys are selected using the soft keys (F1-F4).

5.1 Main Screen

The LCD on the front panel allows direct viewing of the control temperature (actual target temperature), heating or cooling power, stability state, current set-point information, and current program information. The temperature displayed is either in °C or °F. The displayed temperature units can easily be changed by pressing the C/F key on the front panel.

APPARENT TEMPERATURE

This is the radiometric temperature of the target surface as calculated from the control sensor temperature. The calculation depends on the emissivity setting. The controller heats or cools the target to force the control temperature equal to the set-point.

SET-POINT (SETPT)

This is the current set-point.

IRT ϵ

IRT ϵ is the apparent emissivity. In other words, it is the emissivity setting should match that of the UUT.

CAL λ

CAL λ is the bandwidth of the instrument's calibration. It can be set to either 8-14 μm or User.

CONTROL - HEAT/COOL

This shows the relative heating or cooling power (duty cycle) in percent.

HEATING, COOLING, CUTOUT

This shows the status of heating or cooling or the cutout when activated. The bar graph indicates the relative heating or cooling power.

STABLE INDICATION (Graphic)

This shows the stability of the target. When the stability is within the STABLE LIMIT setting, this line is flat.

5.2 Main Menu

The Main Menu is accessed through the MENU button and allows access to all main submenus. The submenus allow the user to setup the instrument as desired and to change system parameters as needed.

5.2.1 TEMP SETUP

The Temp Setup contains IR Calibrator functions related to temperature setup.

5.2.1.1 SETUP

The SETUP menu contains the parameters that set the stability limit and scan rate for the IR calibrator.

5.2.1.1.1 SCAN RATE

The Scan Rate parameter can be set such that when the set-point is changed, the IR Calibrator heats or cools at a specified rate, degrees per minute, ($^{\circ}\text{C}/\text{min}$ or $^{\circ}\text{F}/\text{min}$) until it reaches the new set-point.

The Scan Rate can be set from 0.1 to 500 $^{\circ}\text{C}/\text{min}$ (0.2 to 900 $^{\circ}\text{F}/\text{min}$). However, the maximum scan rate is limited by the natural heating or cooling rate of the instrument, which is often much less than 500 $^{\circ}\text{C}/\text{min}$ (900 $^{\circ}\text{F}/\text{min}$), especially when cooling.

The Scan Rate can be adjusted using the arrow keys. Once the scan rate has been set, press “ENTER” to accept the new scan rate.

5.2.1.1.2 STABLE LIMIT



NOTE: *The IR Calibrator should not be expected to operate better than the stability specification set forth in the Specifications section of this guide. Therefore, the minimum setting of the stability limit should not be less than the stability specification.*

The STABLE LIMIT parameter allows the instrument to notify the user when it has achieved the stability limit set in this parameter. There are two notifications: visual and audible. The visual notification is always active. When the instrument is operating within the stability limit, the stability graph on the main screen remains flat once the instrument is within the given specification for one minute, otherwise the graph indicates the instrument is not yet stable. The audible, if enabled, alerts the user once per set-point when the instrument achieves the set stability limit. Use the arrow keys to set the desired stability limit and press “ENTER” to accept the new stability limit.

Example:

A specific calibration process requires the instrument to operate within $\pm 0.5^{\circ}\text{C}$. “0.5” would be entered into the stability limit parameter. When the instrument’s stability is within $\pm 0.5^{\circ}\text{C}$ for one minute, the graph is flat and the audible alarm (if enabled) notifies the user that the instrument is operating within $\pm 0.5^{\circ}\text{C}$. Use the arrow keys to set the desired stability limit and press “ENTER” to accept the new stability limit.

5.2.1.1.3 STABLE ALARM

The audible alarm described in STABLE LIMIT is turned on or off using the STABLE ALARM parameter. Select either “Enable” or “Disable” using the left or right arrow keys and press “ENTER” to accept the selection.

5.2.1.2 IRT

The IRT menu contains the user settable emissivity parameter that allows the user to set the display emissivity.

5.2.1.2.1 IRT ϵ

The IRT ϵ parameter allows the user to change the display emissivity setting to match the IR thermometer’s emissivity setting.

5.2.1.3 CUTOUT

The Cutout menu contains the Soft and Hard Cutout functions of the instrument.

5.2.1.3.1 SOFT CUTOUT

The Soft Cutout is user settable. As a protection against software or hardware fault or user error, the calibrator is equipped with the adjustable cutout device that shuts off power to the heat source if the target temperature exceeds a set value. It is factory set as a default ten degrees above the high limit of the instrument. If the cutout is activated because of excessive target temperature, power to the heat source shuts off and the instrument cools. The calibrator remains in cutout mode and active heating and cooling are disabled until the user manually resets the cutout. If the over-temperature cutout has been triggered, the instrument displays “CUTOUT” above the duty cycle bar graph, which indicates a cutout condition. The instrument remains in cutout mode until the temperature is reduced and the cutout is reset. The target temperature must drop a few degrees below the cutout set-point before the cutout can be reset.

For safety reasons, the cutout only has one mode — manual reset. Manual reset mode means the cutout must be reset by the operator after the temperature falls below the set-point.

The SOFT CUTOUT parameter can be set to any temperature under the range of the instrument. The cutout should be set within 5-10° of the safety limit of the equipment being calibrated or used with the IR Calibrator.



NOTE: CUTOUT RESET: *If the IR Calibrator exceeds the temperature set in the soft cutout menu or if it exceeds the maximum operating temperature of the instrument, a cutout condition occurs. If this happens, the instrument enters cutout mode and will not actively heat or cool until the user resets the instrument.*

To reset the cutout, the instrument temperature must cool to lower than the cutout set-point. Once the instrument has cooled the user may reset the instrument by pressing “SET PT.” and pressing “ENTER” to engage instrument.

5.2.1.3.2 HARD CUTOUT

The Hard Cutout parameter is a view only function and indicates the factory setting for the hard cutout. The Hard Cutout is not user settable.

5.2.2 PROG MENU

The Prog Menu (PROGRAM MENU) allows access to the automated and manual program selections.

5.2.2.1 SELECT PROG

The SELECT PROG menu allows the user to select a program, 1 – 8.

5.2.2.1.1 PROGRAM

Select the PROGRAM from the listing.

5.2.2.1.1.1 EDIT PROG

The EDIT PROG menu allows the user to edit program parameters.

5.2.2.1.1.1 PROGRAM (view Only)

The PROGRAM parameter indicates the number of the program that is selected.

5.2.2.1.1.2 NAME (view Only)

Program NAME indicates the program name. To set the program name see the PROG:[n]NAME serial command. Example: a thermometer model number.

5.2.2.1.1.3 IRT ϵ

IRT ϵ is the emissivity setting of the IR thermometer to be calibrated.

5.2.2.1.1.4 DISTANCE

DISTANCE is the distance in centimeters (cm) from the IR target to the device under test.

5.2.2.1.1.5 APERTURE

Select YES or NO; Yes indicates that an external aperture is required during calibration.

5.2.2.1.1.6 NO. SETPOINTS

The No. Setpoints is the number of set-points defined for a given program. The number of set-points for each program can be set from 1 to 8 and vary depending on the needs of the user. Set the maximum number of set-points needed for the program selected. Once the number of set-points is selected, press “ENTER” to accept the new setting.

5.2.2.1.1.7 SETPOINT n:

SETPOINT n allows the user to set the temperature for each given set-point. n is a number from 1 to No. Set-points.

5.2.2.2 PROG OPTION

The PROG OPTION allows the user to set program parameters.

5.2.2.2.1 SETTLE TEST

SETTLE TEST is the criteria for determining when the temperature of the surface is stable. The options are: AUTO and LIMIT. AUTO uses a predetermined value for the stability. LIMIT uses the value set by the STABLE LIMIT parameter in the TEMP SETUP|SETUP|STABLE LIMIT window.

5.2.2.2.2 SOAK MINUTES

The Soak MINUTES parameter is the number of minutes that each of the program set-points is maintained. The time starts when the temperature settles to within the specified stability. The stability limit is set in the TEMP SETUP|SETUP|STABLE LIMIT window.

5.2.2.2.3 ADVANCE

ADVANCE allows the user to set the choice of advancing to the next step in the program automatically (AUTO) or being prompted from the screen (PROMPT).

5.2.2.2.4 CYCLES

CYCLES is the number of times that the calibrator repeats the program.

5.2.2.3 RUN PROG

The Run Prog (RUN PROGRAM) menu allows the user to access the program status feature.

5.2.2.3.1 PROGRAM (view Only)

The PROGRAM parameter indicates the number of the program that is selected.

5.2.2.3.2 NAME (view Only)

Program NAME indicates the program name. To set the program name see the PROG:[n]NAME serial command. Example: a thermometer model number.

5.2.2.3.3 STATUS

The Status option controls the state of the program. The user selects RUN to run the program or OFF to turn the program off.

5.2.3 SYSTEM MENU

The SYSTEM MENU allows the user to set up the display settings, communications protocol, password settings, calibrations settings, and to view system information.

5.2.3.1 SYSTEM SETUP

The SYSTEM SETUP menu contains the menus for the display and communications parameters.

5.2.3.1.1 DISPLY SETUP

The DISPLY SETUP (DISPLAY SETUP) menu contains the language selection, decimal separator, and keypad sound parameters.

5.2.3.1.1.1 LANGUAGE

The LANGUAGE parameter is used to set the display language. The instrument supports seven languages; English, Japanese, Chinese, German, Spanish, French, Russian, and Italian depending on the configuration. European: English, French, Spanish, Italian, German, Chinese, Japanese. Russian: Russian, English. Use the right or left arrow key to select the preferred language and press “ENTER” to accept the selection. The user needs to exit from the SYSTEM MENU window in order for the change in language selection to take affect.



NOTE: *If the wrong language is selected, return to the Main Screen by holding EXIT for a few seconds. Once the Main Screen is displayed, simultaneously press and hold F1 and F4 to return to English temporarily. Then return to the DISPLAY SETUP screen and set the correct language.*

5.2.3.1.2 *DECIMAL*

The DECIMAL parameter is used to determine the decimal separator, a comma or a period. Select the desired decimal separator using the right or left arrow key and press “ENTER” to accept the selection.

5.2.3.1.3 *KEY AUDIO*

The KEY AUDIO parameter (F1 and F3 Keys pressed simultaneously) enables or disables the key press beep.

5.2.3.1.2 **COMM SETUP**

The COMM SETUP (COMMUNICATIONS SETUP) menu contains the serial interface parameters. The parameters in the menu are; BAUD RATE and LINEFEED.

5.2.3.1.2.1 *BAUD RATE*

The BAUD RATE parameter determines the serial communication transmission rate or baud. BAUD RATE may be programmed to 1200, 2400, 4800, 9600, 19200, or 38400 baud.

5.2.3.1.2.2 *LINEFEED*

The LINEFEED enables (ON) or disables (OFF) transmission of a line feed character (LF, ASCII 10) after transmission of any carriage-return. The LINEFEED default setting is on. The line feed parameter can be turned on or off as needed by the user.

5.2.3.2 **PASSWORD**

The PASSWORD (PASSWORD SETUP) menu is used to set the system password or set the level of protection that conditionally engages or disengages protection of certain groups of parameters.

5.2.3.2.1 **USER PASSWORD**

The USER PASSWORD parameter allows the user to enter and change the system and conditional password used to access protected menus. The PASSWORD is a number between one and four digits. Each digit of the password can be a number from 0 to 9. The default System Password is “1234”. If desired, the System Password can be changed in this menu by using the up, down arrow keys to enter the new password and pressing “ENTER”.

5.2.3.2.2 **PROTECTION**

The PROTECTION parameter is used to enable (HIGH) or disable (LOW) password protection for the conditional parameters. The password is the same as the system password. The user has the option to conditionally password protect the SOFT CUT-OUT and all of the PROGRAM MENU parameters except SELECT PROG and RUN

PROG. The user selects “HIGH” or “LOW” by using the left and right arrow keys and presses “ENTER” to accept the selection.

5.2.3.3 CALIBRATE



CAUTION: *Calibration parameters must be correct for the instrument to function properly.*

The CALIB (CALIBRATION) menu allows the user access to the calibration parameters for the instrument. Access to the IR target calibration parameters is protected by a password. Calibration parameters are programmed at the factory when the instrument is calibrated. These parameters may be adjusted to improve the accuracy of the instrument by qualified personnel. Instructions for calibration can be found in the “Calibration of Your IR Calibrator” section of this guide.



CAUTION: *DO NOT change the values of the calibration or control parameters from the factory set values unless you are recalibrating the instrument. The correct setting of these parameters is important to the safe and proper operation of the calibrator.*

The parameters in the CALIB menu are set at the factory and must not be altered unless recalibrating the instrument. Recalibration of the instrument should be performed by trained, knowledgeable personnel. The correct values are important to the accuracy and safe operation of the calibrator. Access to these parameters is protected by a password. In the event that the calibration parameters need to be reentered into the instrument, the constants and their settings are listed in the Report of Calibration shipped with the instrument.

5.2.3.3.1 CONT SETUP

The CONT SETUP (CONTROL SETUP) menu is used to access the controller parameters.

5.2.3.3.1.1 TEMP PBAND

The TEMP PBAND parameter is the proportional band in °C that the instrument’s proportional-integral-derivative (PID) controller uses for control.

5.2.3.3.1.2 TEMP INT

The TEMP INT parameter is the integration time in seconds that the instrument’s PID controller uses for control.

5.2.3.3.1.3 TEMP DER

The TEMP DER parameter is the derivative time in seconds that the instrument’s PID controller uses for control.

5.2.3.3.2 IR CAL

The IR CAL (IR CALIBRATION) menu contains the IR target calibration constants, IR CAL 1, IR CAL 2, and IR CAL 3. Use the arrow keys to enter the set-point for each calibration point and press “Enter” to accept the entry. The calibration points should be selected applicable to model with a low, mid-range, and high set-point.

5.2.3.3.2.1 IR CAL 1

The IR CAL 1 parameter is the offset in °C for the IR target accuracy at the 1st calibration point.

5.2.3.3.2.2 IR CAL 2

The TEMP 2 parameter is the offset in °C for the IR target accuracy at the 2nd calibration point.

5.2.3.3.2.3 IR CAL 3

The TEMP 3 parameter is the offset in °C for the IR target accuracy at the 3rd calibration point.

5.2.3.3.2.4 WAVELENGTH

The WAVELENGTH parameter can be set to the default 8 – 14µm or USER selectable. This is to remind the user that the calibrator was calibrated radiometrically in the 8 – 14µm wavelength band.

5.2.3.3.2.5 CALDATE

The CALDATE parameter is the calibration date for the IR target. Use the arrow keys to enter the calibration date in the format yyyy,mm,dd.

5.2.3.4 SYSTEM INFO (view Only)

The SYSTEM INFO (SYSTEM INFORMATION) menu displays manufacturer information regarding the instrument.

5.2.3.4.1 MODEL

The MODEL parameter displays the model number of the instrument.

5.2.3.4.2 SERIAL

The SERIAL (SERIAL NUMBER) parameter displays the serial number of the instrument.

5.2.3.4.3 FW VERSION

The FW VERSION (FIRMWARE VERSION) parameter displays the firmware version used in the instrument.

5.2.3.4.4 CAL DATE

The CAL DATE (CALIBRATION DATE) parameter displays the calibration date of the IR target.

5.2.4 VIEW TEMP

The VIEW TEMP (VIEW TEMPERATURE) menu allows the user to view the BLOCK TEMPERATURE parameter.

5.2.4.1 BLOCK TEMP (view Only)

The BLOCK TEMP (BLOCK TEMPERATURE) parameter allows the user to view the uncompensated control sensor temperature.

6 Basic Infrared Thermometry Theory – Relating to the Use of the 4180 and 4181

Typically, infrared (IR) thermometers have not been used for measurements requiring low uncertainties. Their application has been for use at extremely high temperatures and in applications where accuracy is less important than repeatability.

As infrared thermometers and our understanding of their advantages improve, both absolute accuracy and calibration become more important. This section gives a brief explanation of some important issues surrounding the use and calibration of IR thermometers and how this information relates to the use of the 4180 and 4181 Precision Infrared Calibrators.

6.1 Apparent Temperature Explanation

The 418X products are calibrated using a radiometric calibration. The main display temperature is based on this radiometric calibration. This temperature shows the user what an IR thermometer with a given emissivity setting should read. This is called apparent temperature. The apparent temperature is defined as the temperature an IR thermometer set to emissivity (ϵ) should read when measuring the IR calibrator's surface. In other words, the display temperature shows what temperature the target appears to be to the IR thermometer.

6.2 Spectral Response (Wavelength)

Every object with a temperature above absolute zero (0 Kelvin) radiates energy over a wide spectral band. For example, if a significant part of this energy is within the band of 400–700 nm, we can see that energy. This is the visible light band. This is the case with an electric stove burner at a temperature of 800°C. The burner will appear red or orange to the eye (red hot). That burner is also emitting energy at other wavelengths, which we can not see. This includes wavelengths in the infrared portion of the electromagnetic spectrum.

An example of an object emitting energy at wavelengths we can see is the sun. The sun's surface temperature is about 5750K. According to Wien's Displacement Law, Equation 1 on next page, the peak wavelength for this temperature is about 500nm which happens to be in the visible light band. Thus the eye detects wavelengths corresponding to the temperature of the Sun.

By the same respect, if we are measuring an object at room temperature, (23°C or about 296K), the peak wavelength is 9.8 μ m which is inside the 8 – 14 μ m band. In fact the temperature corresponding to a peak wavelength at 8 μ m is 89°C and the temperature corresponding to a peak wavelength at 14 μ m is -66°C. This is one of the reasons the 8 – 14 μ m is widely used in handheld IR thermometers.

IR thermometers take advantage of this peak wavelength phenomenon. They measure the amount of energy radiating from an object and calculate temperature based on this measured energy. In most handheld IR thermometers, the sensor and optical system measure IR energy in the 8-14 μ m band.

4180, 4181 Precision Infrared Calibrator

Spectral Response (Wavelength)

The mathematical equation describing the spectral power radiated by a perfect black-body for a given wavelength is Planck's Law. If Planck's Law, Equation 2 on this page, is integrated over the entire electro-magnetic spectrum, this gives us the Stefan-Boltzmann Law. This is the T to the 4th law (T⁴). The problem with the Stefan-Boltzmann Law, Equation 3 on this page, is that it is not limited to a specific band. To get the energy within a certain band, we would need to integrate Planck's Law for the limits of this bandwidth. This integral cannot be solved analytically.

The mathematical equation describing the peak wavelength for a given temperature is Wien's Displacement Law.

$$\lambda_{\max} T = c_3$$

Equation 1 Wien's Displacement Law

$$L(\lambda, T) = \frac{c_{1L}}{\lambda \left[\exp\left(\frac{c_2}{\lambda T}\right) - 1 \right]}$$

Equation 2 Planck's Law

$$M = \sigma T^4 = \pi \int_0^{\infty} L(\lambda, T) d\lambda$$

Equation 3 Stefan-Boltzmann Law

The relationship between Planck's Law and Wien's Displacement Law is shown in Figure 9 on opposite page. Notice that the energy peak for the Sun is about 0.5 μ m (500 nm), while at room temperature, 23°C, it is just below 10 μ m.

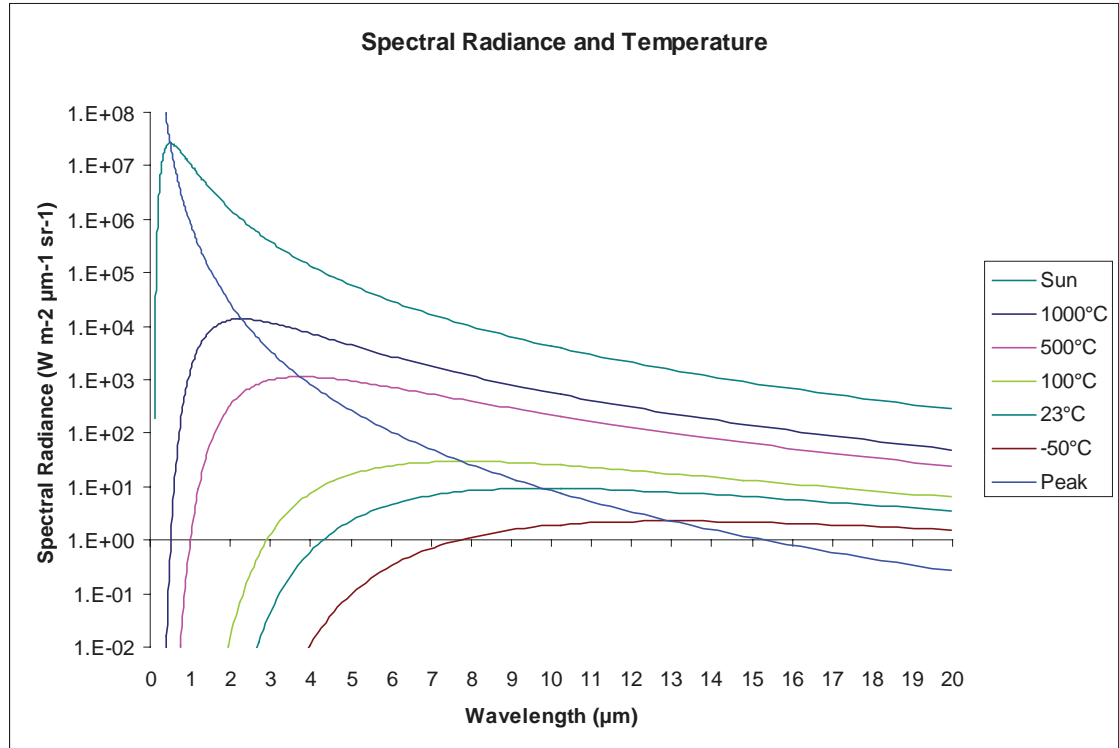

Figure 9 Relation between Planck's Law and Wien's Displacement Law

6.3 Emissivity

Emissivity is defined as the ratio of the energy emitted at a temperature to the energy emitted by a perfect blackbody at that same temperature. A perfect blackbody would have an emissivity of 1.0. However, in the real world there is no such thing as a perfect blackbody.

For example, if a perfect blackbody emits 10000 W/m² at a given temperature and a material emits 5000 W/m² at that same temperature, then the emissivity of that material is 0.5 or 50%. If another material emits 9500 W/m² at that same temperature, it has an emissivity of 0.95.

It is important to note that for any opaque material, the ratio of energy reflected plus the ratio of energy transmitted is equal to 1.0 (this is known as Kirchhoff's Law). So if a material's emissivity is 0.95, the material reflects 5% of the energy radiated by objects facing it. By contrast, if an object has an emissivity of 0.50, the material reflects 50% of the energy radiated by objects facing it. This means this reflected energy can contribute to measurement accuracy. This is especially true when measuring materials with lower emissivity, and objects at lower temperatures.

6.3.1 Uncertainty Caused by Emissivity

A lack of knowledge of emissivity itself can contribute greatly to inaccuracy in IR temperature measurement. Figure 6.2 shows a graph of this phenomenon in the 8-14μm band.

For an example, say we are measuring an object at 500°C. We assume it has an emissivity of 0.95. However, its emissivity is really 0.93. This would cause our 8-14 μm IR thermometer to read the temperature 6.7 degrees low, a -6.7°C error in temperature measurement.

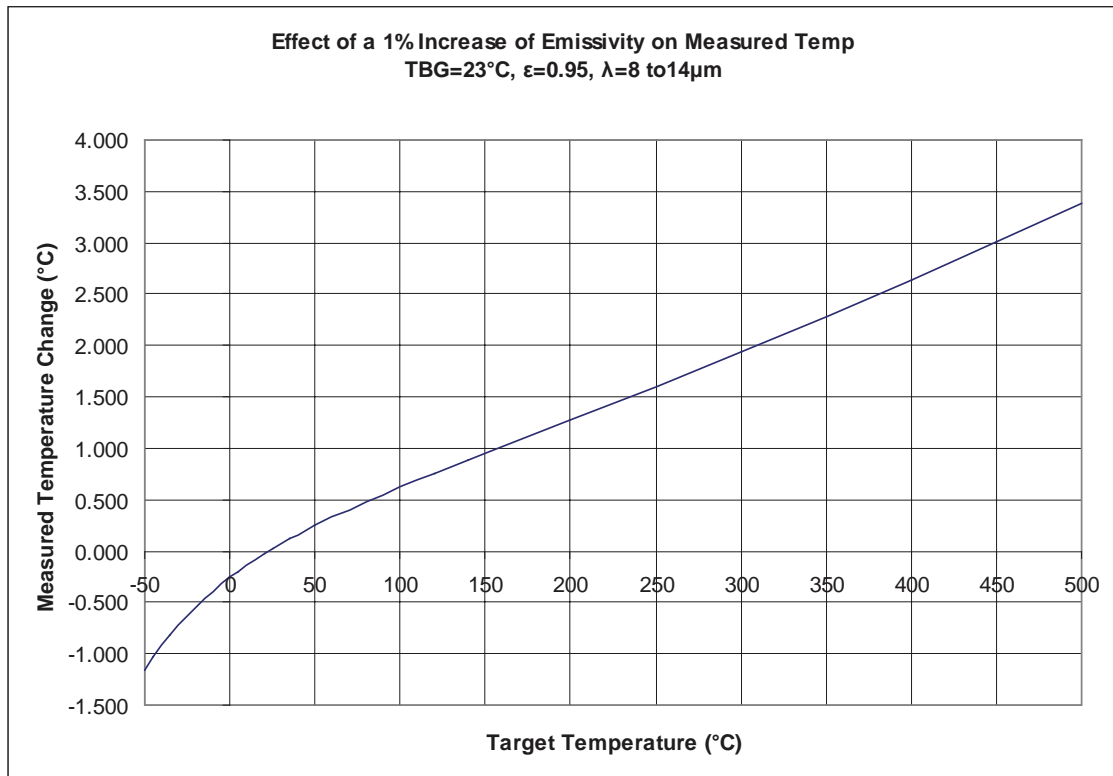

Figure 10 Effect of a 1% increase in emissivity in the 8-14μm band

The emissivity of an object is not an easy thing to determine. One method is to take a calibrated variable-emissivity IR thermometer, aim it properly at the object in question, and adjust its emissivity until its reading matches the known temperature of the object. This gives an average emissivity of the object over the IR thermometer’s bandwidth. This method assumes the measured object is gray.

We term an object as having constant emissivity over all wavelengths as being gray or a gray body. It should be noted that most objects tend not to have a constant emissivity over all bandwidths, thus these objects are not perfect gray bodies. Uncertainties in emissivity values need to be considered in the total uncertainty of measurements with IR thermometers.

One widely used and accepted method in determining the spectral dependence on emissivity (or how emissivity varies with wavelength) is Fourier Transform Infrared (FTIR) testing. A graph from such a test is shown in Figure 14 on page 42.

6.3.2 Effect of Background Temperature

Another effect related to emissivity is that of background temperature. Background temperature is the temperature of objects facing the measured surface. Remember that

when an object has an emissivity of 0.95, it is reflecting 0.05 of background object’s radiation energy. Of course the amount of background radiation is a function of the background objects’ temperature. An example of this effect is shown in Figure 6.3.

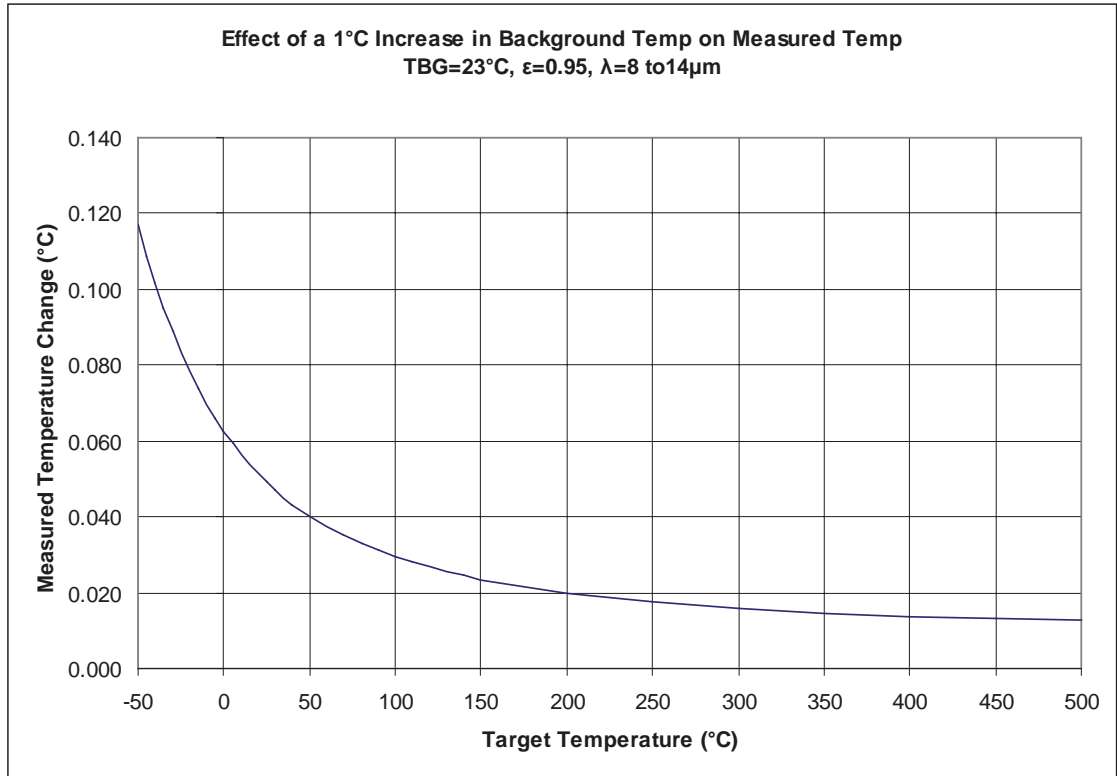

Figure 11 Effect of a 1% increase in background temperature in the 8-14μm band

As can be seen in the graph, the effect of background temperature is more troublesome when measuring lower temperatures than when measuring higher temperatures. The point of this discussion is that in order to do good IR thermometry, background temperature must be controlled.

6.3.3 Effect of Angle on Emissivity

Another topic to be aware of relating to emissivity is that emissivity varies with angle. Typically, emissivity is maximum when taking a measurement normal to an object and is zero when taking a measurement parallel to an object. An example of this effect when using the 418X is shown in Figure 12 on next page. As can be seen in the graph, any measurements made within 15° of normal will cause an error less than 0.001 in emissivity. This number can be evaluated against the graph in Figure 12 to obtain uncertainty due to angular deviation from normal.

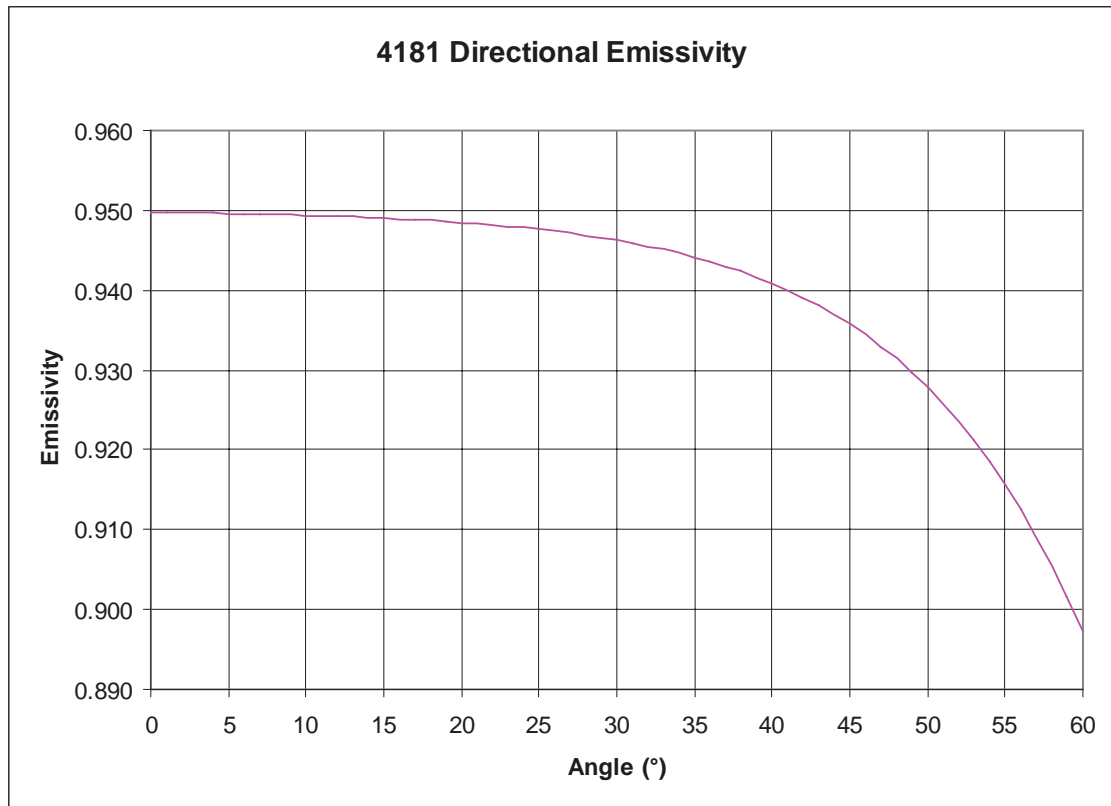

Figure 12 Effect of Angular Emissivity

6.4 Calibration Geometry

Along with emissivity, calibration geometry is one of the most misunderstood topics related to the calibration and use of IR thermometers. Among the topics that are misunderstood are center of spot, size of spot, scatter, size of source and distance to target.

6.4.1 Center of Spot

Many IR thermometers include lasers as a guide to show the user where to point them. These act as approximating guides only. In reality, IR thermometers see areas much bigger than that small laser dot. Also, an IR thermometer's center of spot may not be exactly at the point where the laser is pointed. To understand the impact of these two factors on a calibration, testing should be done to determine the center of the spot. This information may be provided by the manufacturer as well.

6.4.2 Size of Spot, Size of Source and Scatter

IR thermometer manufacturers frequently indicate a distance-to-spot-size ratio. It is computed at specific distances. The spot size is the diameter that contains a given amount of energy detected by the IR thermometer. This is typically 90% to 95% of the energy. This information is also just an approximating guide. The energy outside this detection area is referred to as scatter. This means that a surface area much larger

than the given spot size is needed when calibrating IR thermometers. Spot size is often referred to as size of source effect.

Two solutions to size of source effect problems are available through the calibration of the IR thermometer, both related to calibration geometry including distance and target size. One method is to calibrate the instrument under the same conditions under which it is used. That is, you point it at the same size of target at a known surface temperature as what it is used to measure, from the same distance, and under similar ambient conditions.

The other method is to duplicate the calibration geometry used by the manufacturer of that device. This information should be available from the manufacturer. Under either method, you calibrate in a certain intended amount of scatter into your measurement.

The target size needed to calibrate a given IR thermometer is dependent on the IR thermometer's optical system. Many IR thermometers come with a spot size diagram. These diagrams can be misleading. As mentioned above, all of the energy the IR thermometer detects is within the given spot diagram. Generally you will need at least 2 to 3 times the spot size diameter to use for calibration.

The 4180 and 4181 provide the user with a 150 mm (6 inch) diameter flat plate. This gives the user a large temperature controlled surface to calibrate IR thermometers. 150 mm (6 inches) is a large enough diameter to accommodate most handheld IR thermometers.

6.4.3 Distance to target

The third topic of concern with calibration geometry is distance between the calibration target and the IR thermometer being calibrated. It is important not to have the IR thermometer too close to the target. This will cause the IR thermometer's optics to heat excessively which will cause false readings. It is also important to be not too far away. This will cause the target to not fill the IR thermometer's spot size and will cause a false reading.

6.4.4 Knowing the Correct Geometry

Information on these 3 factors, center of spot, size of source and distance to target, should be provided by the IR thermometer manufacturer. If this information cannot be obtained, ASTM provides a guideline (ASTM Standard E1256-95) to determine some of these parameters.

6.5 Traceability

Hart Scientific's traceability for the 418X calibration comes through a radiometric transfer standard. The 418X is calibrated with an 8-14 μ m highly accurate IR thermometer (radiometer). This IR thermometer is calibrated in blackbody cavity baths. The temperature of these baths is measured by PRTs which have a calibration traceable to NIST. A diagram of this traceability is shown in Figure 13 on next page.

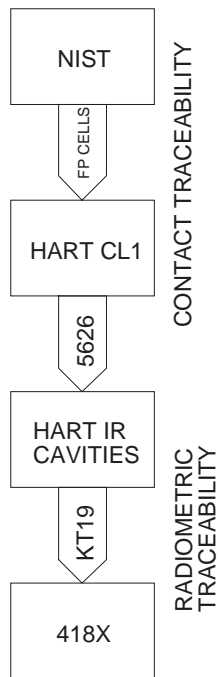

Figure 13 418X Traceability

Note that when an IR thermometer is being calibrated against another IR thermometer using the same temperature source, both should view the same portion of the electromagnetic spectrum. The 418X calibration uses a highly accurate IR thermometer which operates in the 8 – 14 μm band. This should be sufficient to calibrate IR thermometers using this bandwidth. If you need more information about what band the unit under test operates in, consult the unit's user's guide or the unit's manufacture.

The purpose for the radiometric calibration is to account for factors that cannot be accounted for with a contact calibration. The two main factors are the difference between contact temperature and surface temperature, and the difference between the UUT's emissivity setting and the target's surface emissivity. These factors are discussed further in Section 6.7 Use of the 4180 and 4181 in the Context of IR Theory on page 41. The emissivity setting of the IR thermometer used to calibrate the 418X is 0.95.

6.6 Treatment of IR Thermometers

Three other issues require consideration when using or calibrating IR thermometers.

First, they are subject to thermal shock. If an IR thermometer is suddenly introduced to significantly different ambient conditions, it should be allowed time to reach thermal equilibrium.

Second, IR thermometers are subject to measurement influence by ambient conditions and should be calibrated under similar conditions as those under which they will be used.

Lastly, IR measurements can be influenced by the cleanliness of the IR thermometer's optics. They should be cleaned regularly, including immediately prior to calibration. Check with your IR thermometer manufacturer for proper cleaning methods.

IR thermometry is a powerful and useful tool. Measurements are relatively instantaneous and the surface of the object being measured does not need to be touched. These are definite advantages over contact thermometry. The main disadvantage is accuracy. By considering the topics outlined here, you can reduce uncertainties in measurements made by IR thermometers, both during their calibration and during their use. Time should be taken to understand all uncertainties in any temperature measurement, both in contact thermometry and IR thermometry.

6.7 Use of the 4180 and 4181 in the Context of IR Theory

The 4180 and 4181 provide a number of features to facilitate IR measurements in relation to calibration.

First a large temperature controlled surface is provided to accommodate IR thermometers with larger spot sizes. The target's uniformity is specified as well so that the user can make a proper evaluation of calibration uncertainties as related to spot size.

Second, the 4180 and 4181 provide the user with a radiometric calibration instead of a contact calibration. This gives the user a number that is more usable when calibrating an IR thermometer. The radiometric calibration is done with a highly accurate reference IR thermometer which measures in the 8-14 μm band. This is a band common to most handheld IR thermometers.

The radiometric calibration is more useful than a contact calibration for two reasons. First, it reduces the uncertainty caused by a lack of knowledge of the surface's emissivity. Second, there is heat flow between the reference probe and the target surface. This causes a temperature drop between the location inside the block where the contact probe is located and the target surface. A contact calibration would not give the target surface temperature. This would create additional uncertainty in the measured temperature.

The emissivity setting of the 418X should be set to the same setting as the IR thermometer's emissivity setting. If an IR thermometer has adjustable emissivity, this setting should be 0.95 on both instruments. If this is not possible, the 418X can compensate for a limited number of emissivity settings other than 0.95.

If a 418X calibrator is being used to calibrate an instrument that has a spectral response other than 8-14 μm , additional uncertainty will be introduced to the measurement if the user is using the display reading. To facilitate calculation of this additional uncertainty, a graph of the typical emissivity of the paint used on the product has been provided in Section 6.8.

The 4180 purge system provides the user a way to ensure the emissivity remains consistent below the dew point. When used properly, the purge system will keep ice or moisture from forming on the target. Any ice or moisture on the target surface changes the surface's emissivity and can cause errors in the range of 2.0°C. The unit's factory radiometric calibration is done in dried air. This environment has a dew point well below -15°C meaning that no ice or moisture will form on the target.

6.8 Example of 4180 and 4181 Spectral Emissivity and Calibration Spectral Response

Figure 14 on this page and Figure 15 on opposite page are provided to help calculate uncertainty budgets for calibrating IR thermometers. They should be evaluated for any unit that is calibrated using a 4180 or 4181.

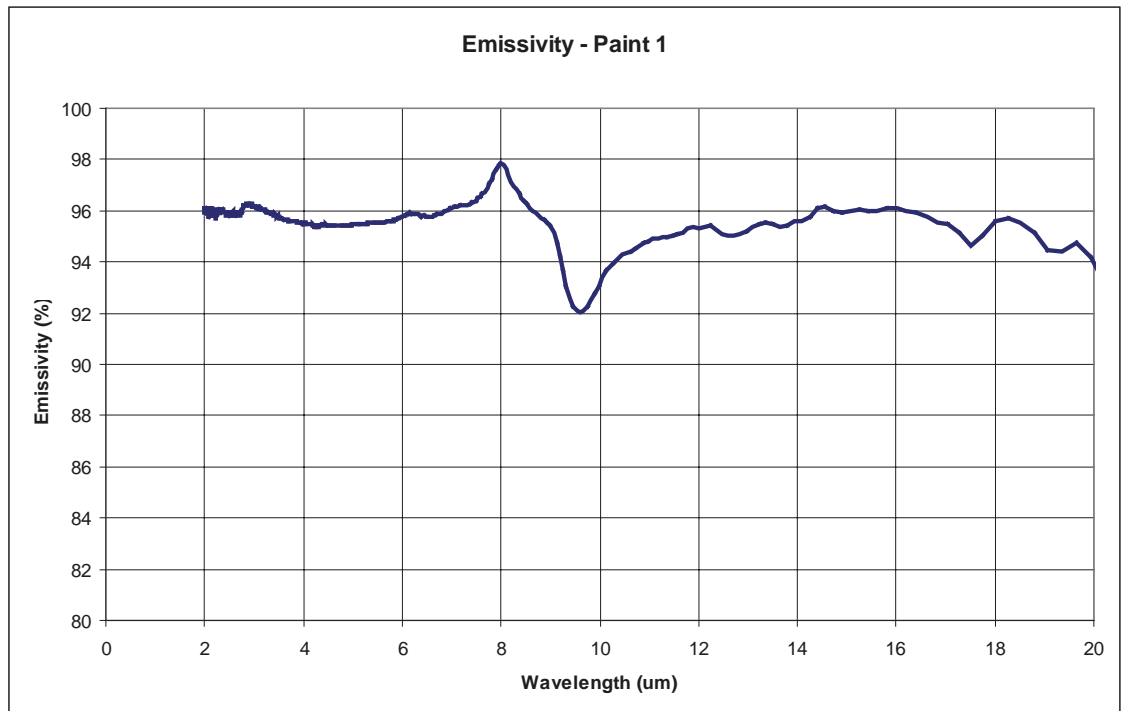

Figure 14 Typical results of FTIR testing on the 418X surface coating.

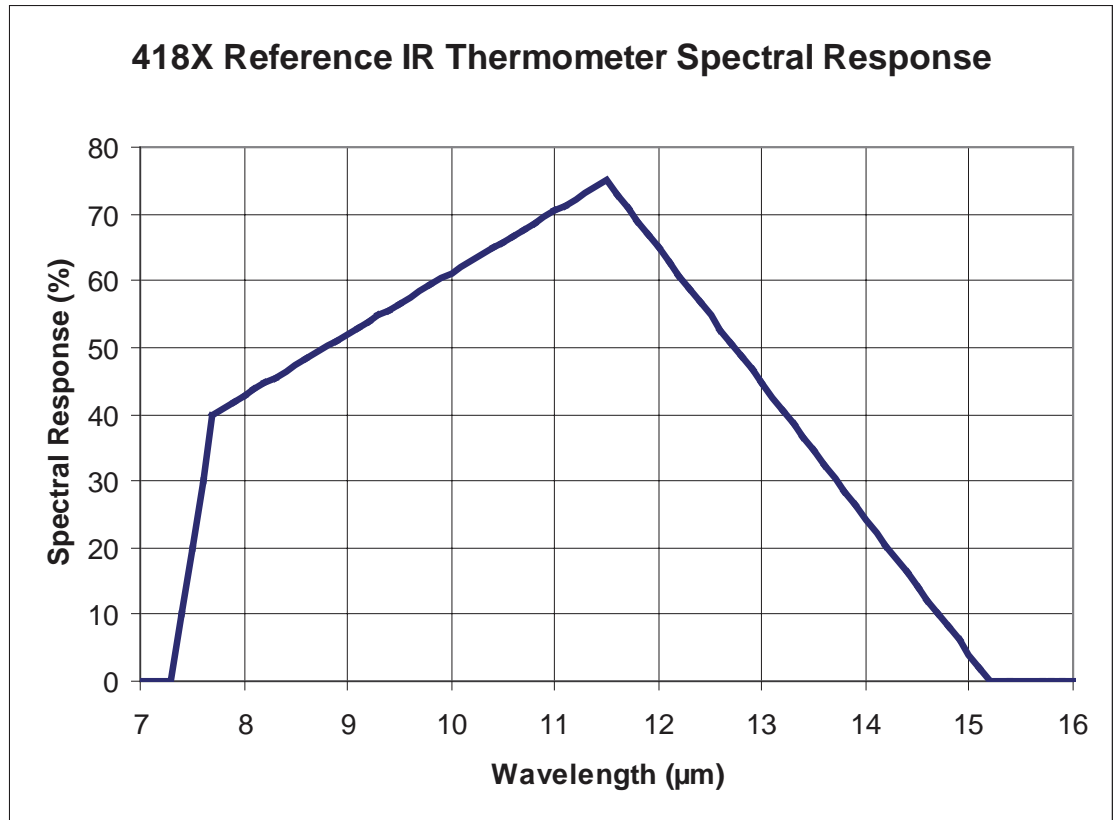

Figure 15 Spectral Response of IR thermometer used to calibrate the 418X.

6.9 Example of an Uncertainty Budget for an IR Thermometer Calibration

The following is an example of an uncertainty budget for the calibration of a theoretical IR thermometer using a 418X calibrator. It is not intended to be an uncertainty budget for any laboratory calibrating IR thermometers. Instead, it is intended to serve as a framework for laboratories to calculate their own uncertainty budget.

6.9.1 Example IR Thermometer Uncertainty Budget

Uncertainties	Denot.	Type	Dist	Divisor	100°C
Target Uncertainties					
Calibration Uncertainty	u1	B	normal	2	0.284
Stability (long term)	u2	A	normal	2	0.050
Uniformity	u3	B	rectangular	$\sqrt{3}$	0.145
Noise	u4	A	normal	2	0.109
Display Resolution	u5	A	rectangular	$\sqrt{3}$	0.005

4180, 4181 Precision Infrared Calibrator

Example of an Uncertainty Budget for an IR Thermometer Calibration

Uncertainties	Denot.	Type	Dist	Divisor	100°C
IR Thermometer Uncertainties					
Readout Resolution	u6	A	rectangular	√3	0.050
Ambient Temperature	u7	B	rectangular	√3	0.030
Noise	u8	A	normal	2	1.000
Atmospheric Losses	u9	B	normal	2	0.010
Angular Displacement	u10	B	rectangular	√3	0.030
Background Temperature	u11	B	rectangular	√3	0.116
Spectral Variation	u12	B	normal	2	0.240
Combined Standard Uncertainty	uc	k=1	normal		0.549
Combined Expanded Uncertainty	U	k=2	normal		1.097

Note that the values in the 100°C column represents the expanded (k=2) uncertainty for normal distributions and half of the difference of bounds for rectangular distributions. A sum of squares of the values in this column divided by the number in the divisor column will give the square of the value for uc, the combined standard uncertainty. Multiplying the combined standard uncertainty by 2 will give the value for the combined expanded uncertainty.

$$a = \sqrt{\left(\frac{u_1}{2}\right)^2 + \left(\frac{u_2}{2}\right)^2 + \left(\frac{u_3}{\sqrt{3}}\right)^2 + \left(\frac{u_4}{2}\right)^2 + \left(\frac{u_5}{\sqrt{3}}\right)^2 + \left(\frac{u_6}{\sqrt{3}}\right)^2 + \left(\frac{u_7}{\sqrt{3}}\right)^2 + \left(\frac{u_8}{2}\right)^2 + \left(\frac{u_9}{2}\right)^2 + \left(\frac{u_{10}}{\sqrt{3}}\right)^2 + \left(\frac{u_{11}}{\sqrt{3}}\right)^2 + \left(\frac{u_{12}}{2}\right)^2}$$

$$U = 2uc$$

Equation 4 Combined Uncertainty for Example Uncertainty Budget

6.9.2 Explanations

u₁: Calibration Uncertainty	This is the uncertainty provided by the IR calibrator manufacturer. It follows a normal distribution.
u₂: Stability (long term)	This is the contribution from possible drift of the IR calibrator during its calibration interval. It is obtained from historical data of the IR thermometer model. It is expected to follow a normal distribution since it is likely affected by a combination of factors.
u₃: Uniformity	This is the contribution from the uniformity of the IR calibrator. The IR thermometer under test has a spot size determined by size of source testing. The contribution of this energy is evaluated against the IR calibrator's uniformity specification. Since the uniformity specification is given as a plus and minus tolerance, it is expected to follow a rectangular distribution.
u₄: Noise	This is the contribution from noise of the IR calibrator. It is based on measured data and follows a normal distribution
u₅: Display Resolution	This is the contribution from quantization error of the IR calibrator readout. It has a rectangular distribution
u₆: Readout Resolution	This is the contribution from quantization error of the IR thermometer readout. It has a rectangular distribution

u_7: Ambient Temperature	This is the contribution from the possible range of ambient temperature, which is given limits of 23°C ±4°C. It is based on information provided by the IR thermometer manufacturer. Ambient temperature is expected to more often be closer to 23°C so a normal distribution is used.
u_8: Noise	This is the contribution from noise of the IR thermometer. It is based on measured data and follows a normal distribution
u_9: Atmospheric Losses	This is the contribution from differences in atmospheric attenuation between calibration of the calibrator and calibration of the IR thermometer. It is based modeling of standard atmospheric data. It is based on a number of factors, so a normal distribution is used
u_{10}: Angular Displacement	For this calibration, the angle is controlled within 5° of normal. According to the IR calibrator manufacturer, this could cause a ±0.0005 change in emissivity. This tolerance is converted to a temperature uncertainty for the uncertainty budget. It is expected to follow a rectangular distribution.
u_{11}: Background Temperature	This is the contribution from changes in temperature of surfaces facing the plate. The plate reflects some of the incident background energy. Since the laboratory walls are the main surface facing the plate, it is based on their temperature variance. This temperature is limited by a tolerance during calibration, so it follows a rectangular distribution.
u_{12}: Spectral Variation	This is the contribution from the uncertainty in the spectral response of the IR thermometer measuring the plate. Since the plate is not a perfect gray body, the spectral response of the emissivity of the IR calibrator's surface must be taken into account. The contribution from the spectral response is based on information given by the IR thermometer manufacturer. The spectral response of the paint is based on emissivity data from the IR calibrator manufacturer. These two data are modeled mathematically to determine the effect of the spectral response uncertainty. This uncertainty is based on a number of factors, so a normal distribution is used.

6.10 Further Reading

The following are excellent resources on IR thermometry theory and good measurement practices.

Theory and Practice of Radiation Thermometry by D.P. DeWitt and Gene D. Nutter (John Wiley & Sons)

Thermal Radiative Transfer and Properties by M. Quinn Brewster (John Wiley & Sons)

Introduction to Radiometry and Photometry by Ross McCluney (Artech House)

E 1256 - 95 in *Annual Book of ASTM Standards Vol. 14.03*, ASTM International, West Conshohocken, PA

U. S. Guide to the Expression of Uncertainty in Measurement (GUM).

7 Digital communication interface

The Infrared Calibrator is capable of communicating with and being controlled by other equipment through the RS-232 digital interface.

With a digital interface the instrument may be connected to a computer or other equipment. This allows the user to input the set-point temperature, monitor the temperature, control operating conditions, and access any of the other controller functions, all using remote communications equipment. The RS-232 serial interface allows serial digital communications over fairly long distances. With the serial interface, the user may access any of the functions, parameters and settings discussed in this section.

7.1 Wiring

The serial communications cable attaches to the instrument through the DB-9 connector at the back of the instrument. Figure 16 on next page shows the pin-out of this connector and suggested cable wiring. To eliminate noise, the serial cable should be shielded, with low resistance between the connector (DB9) and the shield.

7.1.1 Setup

Before operation the serial interface must first be set up by programming the BAUD rate and other configuration parameters. These parameters are programmed within the communications menu. The serial interface parameters can be accessed from the main menu by MENU|SYSTEM SETUP|COMM SETUP|. Refer to “Comm” in the Controller Operation section for more information on the serial interface parameters.

7.1.2 Serial Operation

The serial communications uses 8 data bits, one stop bit, and no parity. The set-point and other commands may be sent via the serial interface to set the temperature set-point and view or program the various parameters. The interface commands are discussed in the “Digital Interface” section.

RS-232 Cable Wiring for IBM PC and Compatibles

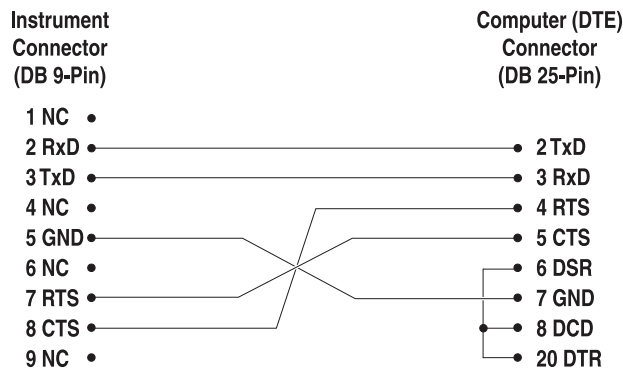
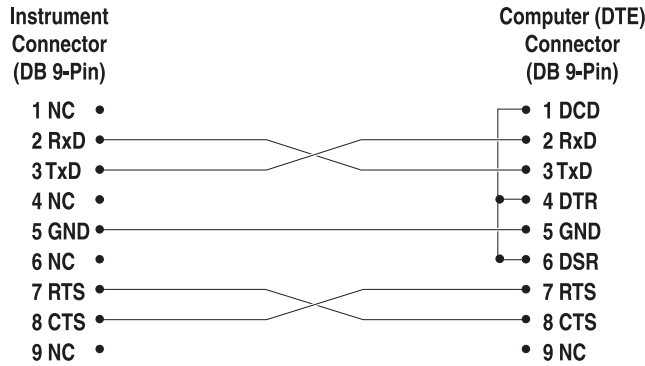

Figure 16 RS-232 wiring

7.2 Command Syntax

Infrared Calibrators accept commands for setting parameters, executing functions or responding with requested data. These commands are in the form of strings of ASCII-encoded characters. As far as possible, the Infrared Calibrator command syntax conforms to SCPI-1994. One notable exception is that compound commands are not allowed as explained below.

Commands consist of a command header and, if necessary, parameter data. All commands must be terminated with either a carriage return (ASCII 0D hex or 13 decimal) or new line character (ASCII 0A hex or 10 decimal).

Command headers consist of one or more mnemonics separated by colons (:). Mnemonics may use letter characters, the underscore character (_), and possibly numeric digits as well. Commands are not case sensitive. Mnemonics often have alternate forms. Most mnemonics have a long form that is more readable and a short form consisting of three or four characters that is more efficient.

A mnemonic may end with a numeric suffix that specifies one of a set of independent function blocks such as input channel data paths. If a numeric suffix is omitted when a particular block must be specified, an error is generated (“Header suffix out of range”).

Query commands are commands that request data in response. Query commands have a question mark (?) immediately following the command header. Responses to query commands are generated immediately and placed in the output buffer. Responses are then transmitted automatically over the RS-232 port. Responses are lost if not read before the next command is received.

Some commands require parameter data to specify values for one or more parameters. The command header is separated from the parameter data by a space (ASCII 20 hex or 32 decimal). Multiple parameters are separated by a comma(,).

Infrared Calibrators do not allow compound commands (multiple commands per line separated with semicolons). All commands are sequential. The execution of each command is completed before subsequent commands are processed.

7.3 Commands by Function or Group

In this section, the commands are arranged into the following groups:

Calibration Commands – commands for Infrared Calibrator calibration parameters.

Main Screen Commands – commands for parameters displayed on the main screen.

Program Commands – commands for program setup and status.

Setup Commands – commands for setting up communication, display, password, measure, and operation parameters.

System Commands – commands to report and change the status of the instrument.

Temperature Commands – commands for control temperature and cutout functions.

Table 4 *Commands by Function or Group*

	SCREEN PARAMETER	Command	Password Protection Group	Read/Write
Calibration - Controller	TEMP PB	SOUR:LCON:PBAN	Unconditional	R/W
	TEMP INT	SOUR:LCON:INT	Unconditional	R/W
	TEMP DER	SOUR:LCON:DER	Unconditional	R/W
Calibration – IR Target	WAVELENGTH	SOUR:CAL:WAV	Unconditional	R/W
	(none)	SOUR:CAL:EMIS	N/A	R
	IR CAL 1	SOUR:CAL:PAR1	Unconditional	R/W
	IR CAL 2	SOUR:CAL:PAR2	Unconditional	R/W
	IR CAL 3	SOUR:CAL:PAR3	Unconditional	R/W
	CAL DATE	SOUR:CAL:DATE	Unconditional	R/W
	Main Screen	(apparent temperature)	SOUR:SENS:DATA [TEMP]	N/A
	SETPT	SOUR:SPO	N/A	R/W

4180, 4181 Precision Infrared Calibrator

Commands by Function or Group

	SCREEN PARAMETER	Command	Password Protection Group	Read/Write
	(graphic)	SOUR:STAB:DATA	N/A	R
	(none)	SOUR:STAB:TEST	N/A	R
	HEAT %	OUTP:DATA	N/A	R
	ENABLE	OUTP:STAT	N/A	R/W
	IRT ϵ :	SOUR:EMIS	N/A	R/W
	CAL λ	SOUR:CAL:WAV	N/A	R/W
	°C/°F key	UNIT:TEMP	N/A	R/W
	SETPT	SOUR:SPO	N/A	R/W
Setpoint	SETPOINT 1	SOUR:LIST:SPO1	N/A	R/W
	SETPOINT 2	SOUR:LIST:SPO2	N/A	R/W
	SETPOINT 3	SOUR:LIST:SPO3	N/A	R/W
	SETPOINT 4	SOUR:LIST:SPO4	N/A	R/W
	SETPOINT 5	SOUR:LIST:SPO5	N/A	R/W
	SETPOINT 6	SOUR:LIST:SPO6	N/A	R/W
	SETPOINT 7	SOUR:LIST:SPO7	N/A	R/W
	SETPOINT 8	SOUR:LIST:SPO8	N/A	R/W
Program - Select	PROGRAM	PROG:SEL	N/A	R/W
Program - Run	TEST STATUS	PROG:STAT	N/A	R/W
Program - Edit	ADVANCE	PROG:PROM:ADV	N/A	W
	(none)	PROG:PROM:STAT	N/A	R
	(none)	PROG:PAR:CAT	N/A	R
	SETPOINT 1	PROG[x]:PAR SPO1	Conditional	R/W
	SETPOINT 2	PROG[x]:PAR SPO2	Conditional	R/W
	SETPOINT 3	PROG[x]:PAR SPO3	Conditional	R/W
	SETPOINT 4	PROG[x]:PAR SPO4	Conditional	R/W
	SETPOINT 5	PROG[x]:PAR SPO5	Conditional	R/W
	SETPOINT 6	PROG[x]:PAR SPO6	Conditional	R/W
	SETPOINT 7	PROG[x]:PAR SPO7	Conditional	R/W
	SETPOINT 8	PROG[x]:PAR SPO8	Conditional	R/W
	NO. SETPOINTS	PROG[x]:PAR POIN	Conditional	R/W
	IRT ϵ :	PROG[x]:PAR IRTE	Conditional	R/W
	DISTANCE	PROG[x]:PAR DIST	Conditional	R/W
	APERTURE	PROG[x]:PAR APER	Conditional	R/W
	NAME	PROG1:NAME	Conditional	R/W
	NAME	PROG2:NAME	Conditional	R/W
	NAME	PROG3:NAME	Conditional	R/W
	NAME	PROG4:NAME	Conditional	R/W
	NAME	PROG5:NAME	Conditional	R/W
	NAME	PROG6:NAME	Conditional	R/W

	SCREEN PARAMETER	Command	Password Protection Group	Read/Write
	NAME	PROG7:NAME	Conditional	R/W
	NAME	PROG8:NAME	Conditional	R/W
	SOAK MINUTES	PROG:OPT:SOAK	N/A	R/W
	SETTLE TEST	PROG:OPT:SETT	N/A	R/W
	CYCLE	PROG:OPT:CYCL	N/A	R/W
	ADVANCE	PROG:OPT:ADV	N/A	R/W
Setup - Communication	BAUD RATE	SYST:COMM:SER:BAUD	N/A	R/W
	LINEFEED	SYST:COMM:SER:LIN	N/A	R/W
Setup - Display	LANGUAGE	SYST:LANG	N/A	R/W
	LANGUAGE	SYST:LANG:CAT	N/A	R
	DECIMAL	SYST:DEC:FORM	N/A	R/W
	KEY AUDIO	SYST:BEEP:KEYB	N/A	R/W
Setup - Password	PASSWORD (Disable)	SYST:PASS:CDIS	Unconditional	W
	PASSWORD (Enable)	SYST:PASS:CEN	Unconditional	W
Status	(none)	SYST:PASS:CEN:STAT	N/A	R
	USER PASSWORD	SYST:PASS:NEW	Unconditional	W
	PROTECTION	SYST:PASS:PROT	N/A	R/W
System - Setup	(none)	SYST:KLOC	Conditional	R/W
System - Information	(none)	SYST:ERR	N/A	R
	(all)	*IDN	N/A	R
	(none)	*CLS	N/A	W
	FW VER	SYST:COD:VERS	N/A	R
	(none)	SYST:BEEP:IMM	N/A	W
Temperature - Setup	SCAN RATE	SOUR:RATE	N/A	R/W
	STABLE LIMIT	SOUR:STAB:LIM	N/A	R/W
	STABLE ALARM	SOUR:STAB:BEEP	N/A	R/W
Temperature - Cutout	HARD CUTOUT	SOUR:PROT:HCUT	N/A	R
	SOFT CUTOUT	SOUR:PROT:SCUT:LEV	Conditional	R/W
Reset	(none)	SOUR:PROT:CLEA	N/A	W
Trip State	(none)	SOUR:PROT:TRIP	N/A	R
View Temp	BLOCK TEMP	SOUR:SENS:DATA [BLOC]	N/A	R

7.4 Serial Commands - Alphabetic Listing

Each command description provides the structure (long and short format), a description of the command purpose, a command example, an example of what the command returns (as applicable to query commands), and notes specific to the command. The following apply to each group of commands:

- Numeric data, specified by the mnemonic, <num>, uses ASCII characters to

represent numbers. Numbers may contain a plus or minus ('+' or '-') sign, decimal point ('.'), and exponent ('E' or 'e') with its sign. If a fractional component is received when only an integer is required, the number is rounded to the nearest integer without any resulting error message. The mnemonics DEF, MIN, and MAX are often acceptable for the default, minimum, and maximum value respectively. Unit suffixes, such as V or OHM, can be appended to numeric parameters and are accepted without error but ignored.

- Unrecognized commands or commands with incorrect syntax or invalid parameters generate error messages in the error queue.
- Upper case letters designate syntax that is required when issuing the command. Lower case letters are optional and may be omitted.
- < > indicates a required parameter.
- [] indicates optional parameters.
- () indicates a group of parameters that must be used together.
- For query commands, specifying the MIN, MAX, or DEF parameter causes the instrument to respond with the minimum, maximum, or default setting respectively.
- For set commands, specifying the MIN, MAX, or DEF parameters causes the instrument to use the minimum, maximum, or default setting respectively.
- '|' indicates alternate parameter values.
- <n> indicates a number is required.
- <num> indicates numeric value is required.
- <prog> indicates a program number (SEQ<n> or SWIT<n>) is required.
- <bool> indicates a Boolean value (0 or 1) is required. The mnemonics OFF and ON are also accepted for 0 and 1, respectively.
- <conv> indicates a conversion mnemonic is required.
- <param> indicates a parameter name is required.
- <seri> indicates a serial number is required.
- <unit> indicates a temperature unit is required.
- <temp> indicates a temperature °C/F is required.
- <pass> indicates a password is required.
- <port> indicates a port number is required.
- <label> indicates an eight character label is required.
- <year> indicates a four digit number is required.
- <month> indicates a one or two digit number is required.
- <day> indicates a one or two digit number is required.
- <hour> indicates a one or two digit number is required.
- <minute> indicates a one or two digit number is required.
- <second> indicates a one or two digit number is required.
- <baud> indicates a valid baud number is required.

***CLS**

Clear the status registers

Example: *CLS

This command has no response.

Clears all status registers (events, operations etc).

***IDN?**

Read the product information (Manufacturer, Model Number, Serial Number, and Firmware Version)

Example: *IDN?

Response: FLUKE,4180,A79002,1.00

OUTP:DATA?

Read the main heat output percent

Example: OUTP1:DATA?

Response: 18.0

This command returns the current main zone heater duty cycle

OUTP:STAT[?] [0|1]

Read or set the Main Heat output enable, off [0] or on [1]

Read Example: OUTP:STAT?

Response: 0

Set Example: OUTP:STAT 1

This command reads or sets the active heating or cooling output status. A “0” is returned if the output status is off, and a “1” is returned if the output status is on

PROG:[n]NAME?

Read or set the program name by identifier by n, 1 - 8. Where name consists of 1 to 10

Characters of ‘0’ to ‘9’, ‘A’ to ‘Z’ and ‘-’. If n is omitted, the selected program is assumed.

Read Example: PROG:[1]NAME?

Response: “PROG”

Set Example: PROG:[1]NAME newprog01A

PROG:OPT:ADV n

Read or set the program advance option, 0 (prompt) or 1 (continue automatically)

Read Example: PROG:OPT:ADV?

Response: 0

Set Example: PROG:OPT:ADV 1

PROG:OPT:CYCL n

Read or set the program cycles, 1 to 999, default 1.

Read Example: PROG:OPT:CYCL?

Response: 123

Set Example: PROG:OPT:CYCL 150

PROG:OPT:SETT n

Read or set the program settle option, 0 (apply default limit) or 1 (apply STABLE LIMIT setting).

Read Example: PROG:OPT:SETT?

Response: 1

Set Example: PROG:OPT:SETT 1

PROG:OPT:SOAK n

Read or set the program soak time, 0 to 500 minutes. Default 1

Read Example: PROG:OPT:SOAK?

Response: 15

Set Example: PROG:OPT:SOAK 350

PROG[n]:PAR? PAR

Read or set a program parameter, for a given program identified by n, n = 1 to 8, where par is the parameter that you want to read. Parameters are SPOi, POIN, IRTE, DIST, and APER.

SPOi = setpoints (1-8), where i = the value of one setpoint.

POIN = the number of setpoints for the indicated program.

IRTE = the emissivity ϵ value 0.9 to 1.0, default 0.95.

DIST = the distance from the target to the UUT in cm, 0.1 to 999.9.

APER = yes or no to prompt user for the aperture. 0 = none, 1 = prompt user

Read Example: PROG[1]PAR? DIST?

Response: 100.0

Set Example: PROG[1]:PAR DIST,150

PROG:PAR:CAT?

Read a list of program parameters.

Read Example: PROG:OPT:SOAK?

Response: "SPO8","POIN","IRTE","DIST","APER"

PROG:PROM:ADV

Advance to the next program step if waiting for user input.

Set Example: PROG:PROM:ADV

PROG:PROM:STAT?

Read the manual program advance prompt state, 0(operating or program off) or 1 (waiting for user input).

Read Example: PROG:STAT?

Response: 0

PROG:SEL?

Read or set the program selection, 1 to 8.

Read Example: PROG:SEL?

Response: 3

Set Example: PROG:SEL 2

PROG:STAT?

Read or set the program execution state for the selected program, 0(off) or 1(run).

Read Example: PROG:STAT?

Response: 0

Set Example: PROG:STAT 1

SOUR:CAL:DATE?

Read the instrument calibration date in yyyy,mm,dd format.

Read Example: SOUR:CAL:DATE?

Response: 2007,1,18

SOUR:CAL:DATE y,m,d

Set the instrument calibration date in yyyy,mm,dd format., year range 2000 to 2999.

Set Example: SOUR:CAL:DATE 2008,12,30



***NOTE:** This command is unconditionally protected, which requires a password to set it.*

SOUR:CAL:EMIS?

Read the nominal IR calibration emissivity (0.95).

Read Example: SOUR:CAL:EMIS?

Response: 0.950

SOUR:CAL:PARx?

Read a control temperature parameter, where “x” is a numeric value indicating the parameter, valid values are 1,2, or 3 representing IR CAL 1, IR CAL 2, and IR CAL 3.

Read Example: SOUR:CAL:PAR2?

Response: 0.20

SOUR:CAL:PARx n

Set a control temperature parameter, where “x” is a numeric value indicating the parameter, valid values are 1,2, or 3 representing IR CAL 1, IR CAL 2, and IR CAL 3. Range = +/-99.0; default: 0.0

Set Example: SOUR:CAL:PAR2 0.2



***NOTE:** This command is unconditionally protected, which requires a password to set it.*

SOUR:CAL:PARx:TEMP?

Read the calibration temperature associated with a calibration parameter, where “x” is a numeric value indicating the parameter, valid values are 1,2, or 3.

Read Example: SOUR:CAL:PAR1:TEMP?

Response: -15.0

SOUR:CAL:WAV?

Read or set the calibration IR wavelength option, 0(8-14um) or 1(undefined); default 0.

Read Example: SOUR:CAL:WAV?

Response: 0

Set Example: SOUR:CAL:WAV 1

SOUR:EMIS?

Read or set the IR emissivity setting, range 0.90 to 1.0, default 0.95.

Read Example: SOUR:EMIS?

Response: 0.950

Set Example: SOUR:EMIS 0.90

SOUR:LCON:DER[?] [n]



***NOTE:** This command is unconditionally protected, which requires a password to set it.*

Read or set the main control loop derivative time in seconds, Min: 0.0, Max: 99.9

Read Example: SOUR:LCON:DER?

Response: 1.5

Set Example: SOUR:LCON:DER 5

The main zone derivative is the derivative time in seconds that the unit's PID controller uses for main zone control.

SOUR:LCON:INT[?] [n]



***NOTE:** This command is unconditionally protected, which requires a password to set it.*

Read or set the main control loop integral time in seconds. Range = {10.0-999.9}

Read Example: SOUR:LCON:INT?

Response: 20.0

Set Example: SOUR:LCON:INT 10

The main zone integral is the integration time in seconds that the unit's PID controller uses for main zone control.

SOUR:LCON:PBAN[?] [n]



***NOTE:** This command is unconditionally protected and requires a password to set it.*

Read or set the main control loop proportional band, °C. Range = {1.0-99.9}

Read Example: SOUR:LCON:PBAN?

Response: 1.5

Set Example: SOUR:LCON:PBAN 7

The main zone proportional band is the gain inverse in °C that the unit's proportional-integral-derivative (PID) controller uses for main zone control.

SOUR:LIST:SPO<i>[?] [n]

Read or set a main temperature preset set-point

Read example: SOUR:LIST:SPO6?

Response: 25.00

Set Example: SOUR:LIST;SPO6 100.00

SOUR:PROT:CLEA

Reset the cutout to enable the system

Example: SOUR:PROT:CLEA

This command has no response.

If the IR Calibrator exceeds the temperature set in the soft cutout menu or if it exceeds the maximum operating temperature of the instrument, a cutout condition occurs. If this happens, the unit enters cutout mode and will not actively heat or cool until the user issues this command to clear the cutout or resets the instrument using the Setpt. key to clear the cutout mode and activate the instrument.

SOUR:PROT:HCUT?

Read the hard cutout temperature set-point in °C or °F

Read Example: SOUR:PROT:HCUT?

Response: 140

Returns the current value of the hard cutout set-point.

SOUR:PROT:SCUT:LEV[?] [n]



***NOTE:** This command is conditionally protected and requires a password to set it.*

Read or set the soft cutout set-point where “n” is an integer value from 0 to 700

4180 Range = {0.00 to 140.00}

4181 Range = {0.00 to 520.00}

Read Example: PROT:SCUT:LEV?

Response: 125

Set Example: PROT:SCUT:LEV 450

Read or set the soft cutout set-point. The soft cutout should be set to protect the temperature limits of the instruments under test.

SOUR:PROT:TRIP?

Read the temperature cutout tripped state. Range = {0, 1}; 0 = No Cutout; 1 = Cutout

Example: SOUR:PROT:TRIP?

Response: 0

A value of 0 is returned if the cutout set point has not been reached. Otherwise a value of 1 is returned and the cutout set point has been reached.

SOUR:RATE[?] [n]

Read or set the control temperature rate of change (Scan Rate), °C or °F per minute.
Min: 0.10, Max: 500.00; Default: 100.00

Read Example: SOUR:RATE?

Response: 0.531

Set Example: SOUR:RAT 1.26

The response to this command starts out high initially and decreases as the set point is reached.

SOUR:SENS:BLOC?

Reads the target temperature (uncompensated sensor temperature MENU|VIEW TEMP|BLOCK TEMP) in °C or °F.

Read Example: SOUR:SENS:BLOC?

Response: 24.091

SOUR:SENS:DATA?

Reads the apparent temperature, in °C or °F.

Read Example: SOUR:SENS:DATA?

Response: 24.091 (current apparent temperature)

SOUR:SPO[?] [n]

Set the control set-point, °C or °F, where “n” is a real value with acceptance limits based on the model.

4180, 4181 Precision Infrared Calibrator

Serial Commands - Alphabetic Listing

Parameter	Min	Max	Default
4180	-15.00	120.00	25.00
4181	25.00	500.00	25.00

Read Example: SOUR:SPO?

Response: 50.000

Set Example: SOUR:SPO 100.00

SOUR:STAB:BEEP[?] [n]

Read or set the stability alert (beep) enable where “n” is a value 0 or 1. [0] is disable, [1] is enable beep. Default: 1 (Enable Beep)

Read Example: SOUR:STAB:BEEP?

Response: 1

Set Example: SOUR:STAB:BEEP 0

Enable or disable the audible stability alert.

SOUR:STAB:DAT?

Read the control temperature stability, °C or °F

Example: SOUR:STAB:DAT?

Response: 0.306

The controller stability is returned.

SOUR:STAB:LIM[?] [n]

Read or set the control temperature stability limit, °C or °F where “n” is a positive real value. Range = {0.01 to 5.0 (°C)}; Default: 0.1 (°C) (Model 4180) 0.4 (°C) (Model 4181)

Read Example: SOUR:STAB:LIM?

Response: 0.1

Set Example: SOUR:STAB:LIM 0.09

SOUR:STAB:TEST?

Read the temperature stability test results. Stable = 1; Unstable = 0

Example: SOUR:STAB:TEST?

Response: 0

A value of 0 is returned if the controller is not stable at the current set-point. Otherwise a value of 1 is returned if the controller is stable at the current set-point.

SYST:BEEP:IMM

Beep the system beeper

Example: SYST:BEEP:IMM

The system beeper should make an audible sound in response to this command.

SYST:BEEP:KEYB[?] [n]

Read or set the keyboard beep function, 0=Off, 1=On. Default: 1

Read Example: SYST:BEEP:KEYB?

Response: 1

Set Example: SYST:BEEP:KEYB 1

Turns the keyboard beep function on or off.

SYST:COD:VERS?

Read the main code version

Example: SYST:COD:VERS?

Response: 1.10

Provides the user with the version of the main processor code.

SYST:COMM:SER:BAUD[?] [<baud>]

Read or set serial interface baud rate where “baud” is a standard baud rate value.

Range baud = {1200, 2400, 4800, 9600, 19200, and 38400}; Default: 9600

Read Example: SYST:COMM:SER:BAUD?

Response: 2400

Set Example: SYST:COMM:SER:BAUD 9600

SYST:COMM:SER:LIN[?] [n]

Set serial interface linefeed enable, where “n” is a value 1 or 0. [0] = LF OFF, [1] = LF ON; Default: 0 (OFF)

Read Example: SYST:COMM:SER:LIN?

Response: 0

Set Example: SYST:COMM:SER:LIN 1

This command enables or disables line feed.

SYST:DEC:FORM[?] [n]

Read or set the decimal format, where “n” is period [0], comma [1]. Default: 0 (Period)

Read Example: SYST:DEC:FORM?

Response: 0

Set Example: SYST:DEC:FORM 1

SYST:ERR?

Read the most recent error from the error queue

Example: SYST:ERR?

Response: command protected

This command response reports the errors in the error queue.

SYST:KLOC[?] [n]



NOTE: This command is unconditionally protected and requires a password to set it.

Read or set the keypad lockout; [0] = unlock, and [1] = lock. Default: 0 (Unlock)

Read Example: SYST:KLOCK?

Response: 1

Set Example: SYST:KLOC 1

This command locks or unlocks the system keypad providing control only through the serial interface (RS-232 port) or the keypad.

SYST:LANG[?] [lang]

Read or set the display language, where “lang” is ENGL, FREN, SPAN, ITAL, GERM, RUSS, JAP, CHIN; Default: English. (Default: Russian for Model 418x-RS)

Read Example: SYST:LANG?

Response: ITAL

Set Example: SYST:LANG ENGL

SYST:LANG:CAT?

Read the available display languages,

Read Example: SYST:LANG:CAT?

Response: "ENGL", "FREN", "SPAN", "ITAL", "GERM", "JAP", "CHIN"

SYST:PASS:CDIS

Disable access to password protected setting commands

Example: SYST:PASS:CDIS

This command has no response.

This command disables the system password protection.

SYST:PASS:CEN [n]

Enable access to password protected setting commands, where “n” is a four digit password. Range = {0000 – 9999};

Example: SYST:PASS:CEN 1234

This command has no response.

This command enables the system password. This password needs to be enabled in order to use the conditionally protected commands. When the power of the instrument is cycled, system password protection is disabled.

SYST:PASS:CEN:STAT?

Read the access state of password protected setting commands.

Example: SYST:PASS:CEN:STAT?

Response: 0

This command reports the current status of the system password.

SYST:PASS:NEW n



***NOTE:** This command is unconditionally protected, which requires a password to set it.*

Set the password, where “n” is the new four digit password. Range = {0000 – 9999};
Default: 1234

Example: SYST:PASS:NEW 1234

This command has no response.

This command allows the user to set the system password.

SYST:PASS:PROT[?] [0|1]

Read or set password protection level., [0] = low, [1] = high

Read Example: SYST:PASS:PROT?

Response: 0

Set Example: SYST:PASS:PROT 1

4180, 4181 Precision Infrared Calibrator

Serial Commands - Alphabetic Listing

UNIT:TEMP[?] [n]

Read or set the display temperature units, where “n” is a character “C” or “F”. Default: C

Read Example: UNIT:TEMP?

Response: C

Depending on units setting, a C (Celsius) or F (Fahrenheit) is returned.

8 Calibration of Your Precision Infrared Calibrator

8.1 General



NOTE: For assistance with the process or any questions regarding the calibration of the IR Calibrator, contact an Authorized Service Center.

This procedure is to be considered a general guideline. Each laboratory should write their own procedure based on their equipment and their quality program. Each procedure should be accompanied by an uncertainty analysis also based on the laboratory's equipment and environment.

The 418X Precision Infrared Calibrators are calibrated with a traceable radiometric (non-contact) calibration at the factory. This calibration is supported by good practices including an extensive uncertainty budget. The 418X factory calibration is not based off of a contact calibration.

8.2 Introduction

The radiometer used for the factory calibration has a spectral response of 8-14 μm . This spectral response is used because it matches the bulk of handheld IR thermometers sold today. It is important that the radiometer used for calibration have the same spectral response as the IR thermometer being calibrated. If they do not have the same spectral response, this will give an IR thermometer calibration using the 418X greater uncertainty.

The radiometer must have low enough uncertainties to fit within your uncertainty budget. These uncertainties consist of a number of items including the radiometer's calibration uncertainty and the radiometer's long term drift. There are other uncertainties to consider as well.

8.3 Terminology

Calibration of the IR Calibrator is referred to as the IR Target Calibration.

This calibration process is for a radiometric calibration. It is not for a contact calibration. The instrument was originally calibrated at the factory with a radiometric calibration.



NOTE: The Measuring and Test Equipment (M&TE) is referred to as the Unit Under Test (UUT).

8.4 Fundamentals

It is assumed that the technician is familiar with the 418x Precision Infrared Calibrator User's Guide and Technical Guide.

The operator shall be familiar with the User's Guide for the humidity readout.

The operator shall be familiar with the User's Guide for the radiometer.

It is assumed that the calibration will only be performed by trained personnel.

8.5 Environmental Conditions

Temperature range: $23^{\circ}\text{C} \pm 3^{\circ}\text{C}$

Ambient relative humidity: below 60%

8.6 Calibration Equipment

Table 5 Test Equipment Specifications

CLASSIFICATION	MINIMUM USE SPECIFICATIONS
Primary Reference	
Readout	20 ppm
Aperture Sensors	$23^{\circ}\text{C} \pm 5^{\circ}\text{C}$ Uncertainty: $\pm 0.1^{\circ}\text{C}$
Humidity Readout	Range: -30°C Frost Point or lower
Radiometer	Spot Size: 99.99% of energy within 35 mm diameter at 440 mm distance Spectral Response: 8-14 μm Uncertainties: within your uncertainty budget
Water Cooled Aperture (4180 only)	35 mm in diameter
Chiller (4180 only)	Enough capacity to keep aperture within the specifications of Table 6 on page 71
Air Dryer/Filter (4180 only)	Enough capacity so that the system is capable of reaching a dew point 10° below the coldest calibration point

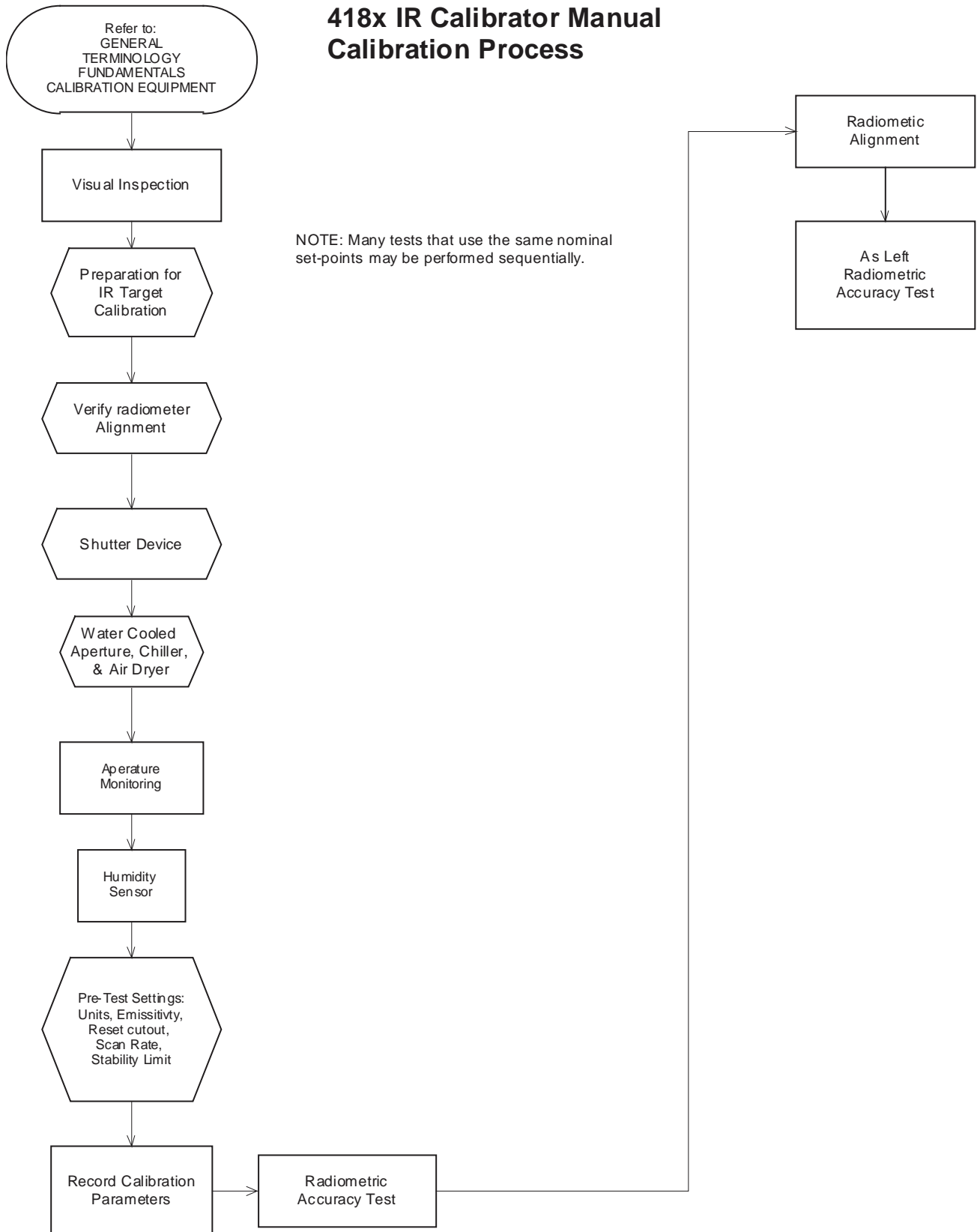

Figure 17 Flow chart for manual calibration

8.7 Procedure

8.7.1 Visual Inspection

Perform a visual inspection of the UUT for signs of physical damage. If a problem is found, correct it before proceeding with the test.

Examine the target for debris or damage. If the target is damaged, contact Customer Service if the UUT is in for repair or recalibration before proceeding.

8.7.2 Manual IR Target Calibration

8.7.2.1 Fundamentals

8.7.2.1.1 General

Calibration of the IR Calibrator involves delicate equipment with some unusual requirements. This procedure basically outlines a manual process that closely follows the way the calibrator was calibrated at the factory. The user is free to adjust their calibration process to meet the needs of their facility and process.

Ensure that calibration technician is familiar with the Infrared Thermometry Theory section of this manual.

8.7.2.1.2 Radiometer

The radiometer required as the reference standard has some tight specifications. This means that the instrument requires a certain level of care. The lens must be kept clean. Dust accumulation on the lens can affect measurement accuracy. Additionally, the radiometer should be shielded from any vibration. Subjecting the radiometer to vibration can cause the radiometer to drift.

8.7.2.1.2.1 Calibration Geometry

Refer to the owner's manual for the radiometer to determine the calibration geometry. If the information is not in the owner's manual, contact the manufacturer. Set up the calibration station as applicable for your radiometer with regards to distance.

8.7.2.1.2.2 Alignment

Proper alignment of the radiometer with the target is essential. The radiometer should be aligned using the laser within 0.15 inches of the center of the IR calibrator target. An adjustable base plate for the radiometer helps to make any adjustments required to align the radiometer in the center of the target. Refer to Figure 18 on page 70, 4180 and 4181 Calibration Model to see the reference of how the alignment is set.

8.7.2.1.3 Aperture

Many radiometers require the use of an aperture to reduce the effect of scatter. Use of a non-temperature controlled aperture requires that the aperture only be in place during the time the measurement is being taken, one minute or less. Leaving the aperture in place longer causes measurement error.

8.7.2.1.3.1 Water Cooled Aperture

A water cooled aperture provides a temperature controlled environment to control scatter. It reduces uncertainty in measurement. A chiller can be utilized to control the temperature of the aperture throughout the temperature range of the IR Calibrator. Refer to Figure 18 on next page, 4180 and 4181 Calibration Model to see how the water cooled apertures and chiller fit into the calibration scheme.

The temperature of the aperture needs to be measured if it is to be temperature controlled. PRTs are utilized to monitor the aperture temperature. (Thermistors could also be utilized.)

Steps and information regarding the water cooled aperture and chiller are provided in the procedure. If you are using a temperature controlled aperture, these steps may be applicable to your process. If you are not using a temperature controlled aperture, these steps will not be applicable to your process.

8.7.2.1.4 Frost Control

The 4180 will form frost on the target at temperatures below the dew point. Thus, during calibration at low temperatures, the calibrator requires that the surface of the target be purged with clean, dry air. This can be accomplished utilizing the purge provided on the 4180 or with a chamber.

8.7.2.1.4.1 Humidity Controlled Chamber

The humidity controlled chamber is a chamber built that fits snugly against the front of the 4180 face plate on one side and the radiometer fits snugly into the other side. Clean, dry, filtered shop air is passed through the chamber at a rate sufficient to keep the target from icing. A humidity sensor and readout are utilized to monitor the humidity in the chamber and ensure the chamber stays below the frost point. Figure 18 on next page, 4180 and 4181 Calibration Model shows the location of the humidity chamber in front of the 4180 portion of the test station.

4180, 4181 Precision Infrared Calibrator

Procedure

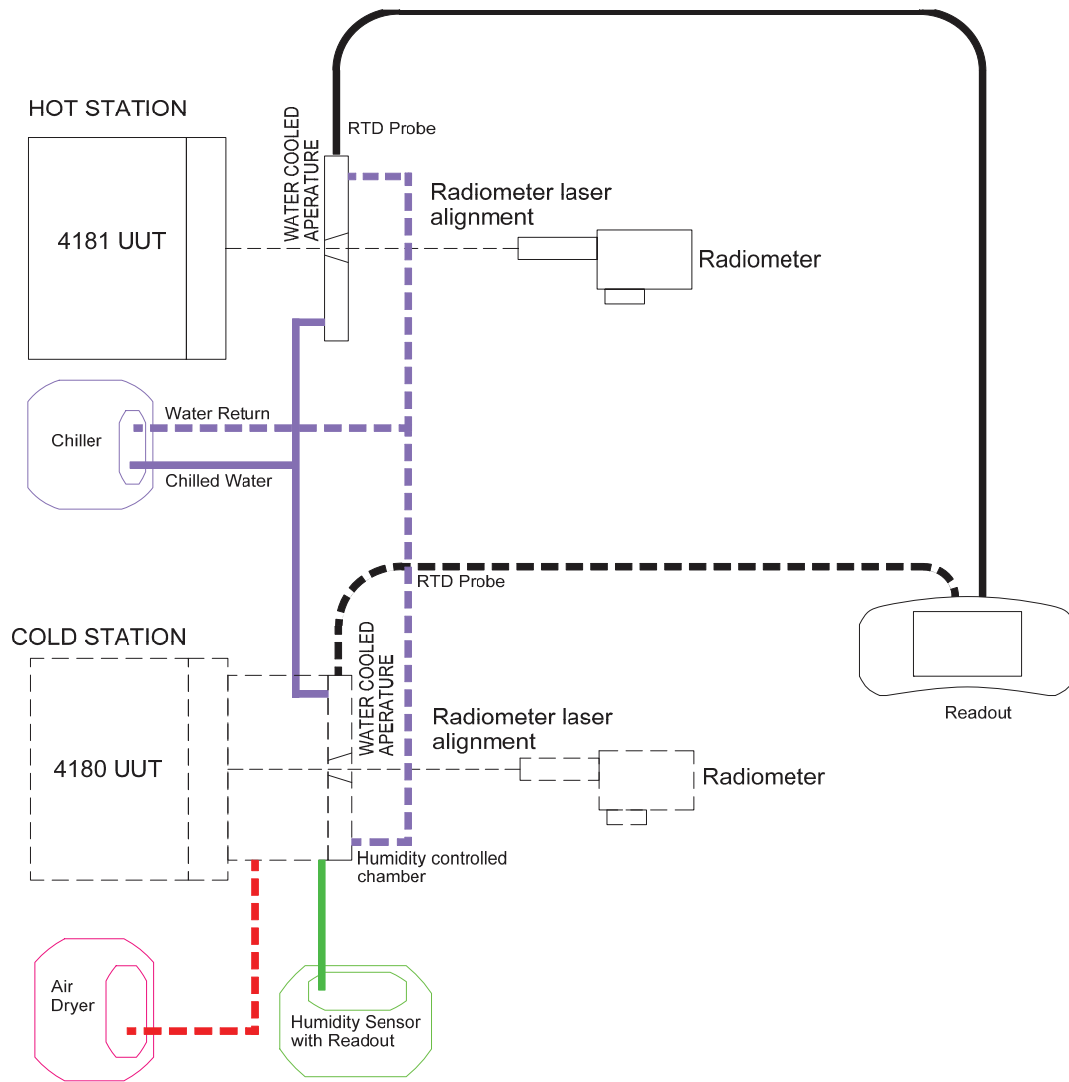

Figure 18 4180 and 4181 Calibration Model

8.7.2.2 Preparation for IR Target Calibration

8.7.2.2.1 Record radiometer calibration constants

Record the radiometer calibration constants, A, B, C, D and T₀ to be used to perform the apparent temperature calculations from radiance measurements taken from the radiometer.

8.7.2.2.2 Verify the radiometer mounting alignment on the test station

Activate the laser alignment on radiometer.

Check alignment.

Adjust mounting bracket for the radiometer as necessary.

8.7.2.2.3 Lens Protection

1. Due to the delicate nature of the radiometer lens, keep the lens covered except when taking measurements.
2. The lens cover shall be removed prior to taking measurements and replaced immediately after measurements to minimize the lens' exposure.
3. The lens cap must be removed at least 30 seconds prior to taking the first measurement from the radiometer.

8.7.2.2.4 Water Cooled Aperture, Chiller, Air Dryer, and Temperature Monitoring

1. If using both a hot UUT (4181) and a cold UUT (4180), one aperture is recommended for the hot UUT and one aperture is recommended for the cold UUT.
2. A chiller is used to maintain a constant temperature of the water that circulates through the apertures. The chiller shall be set to maintain the water at a constant 23°C. Table 6 on this page indicates the chiller setting based on the UUT set-point temperature to maintain a constant 23°C within the given tolerance.

Table 6 *Chiller Setting per UUT Set-Point*

Nominal UUT Set-point (°C)	Baseline (°C)	Tolerance (±°C)
-15	22.9	0.5
0	23.0	0.5
35	23.0	0.5
50	23.0	0.5
100	23.1	0.5
120	23.1	0.5
200	23.2	0.5
350	23.8	0.8
500	25.0	2.0

3. The aperture for each UUT shall be connected to the chiller in parallel.
4. The chiller shall also be connected to the Humidity Sensor as explained in the following section.
5. An air dryer and filter are also required for the cold UUT. The purpose of the air dryer is to filter the air. The source of the air shall remain on constantly and dry.
6. A pressure regulator on the line shall be set to 30 psi and a flow meter shall be used to limit the air flow to 40 l/m. The air flow shall be checked prior to performing each calibration.
7. RTD Aperture probes shall monitor the temperature of the water at each aperture to ensure that it remains constant. These probes are connected to the readout. The technician shall set the readout to take readings on at a 10 second interval from the aperture probes while tests are being performed. The

technician needs to periodically throughout the testing process check that the water is within the range of Table 6.

8.7.2.2.5 Humidity Sensor

Calibration of the cold UUT (4180) requires a humidity sensor. The purpose of the humidity sensor is to ensure proper humidity levels for calibrating the cold UUTs.

The humidity readout may be left on when not taking measurements. However, it should only be enabled to take measurements during the calibration process. The measurement capability should be disabled when not calibrating.

The humidity readout needs to be monitored during the testing process. If the dew or frost point rises above -30°C the dew point measurement is out-of-tolerance.

8.7.2.3 Settings

8.7.2.3.1 Pre-Test UUT Settings

Before starting a calibration, the following UUT configuration and control settings must be set to the indicated values, *even if As Found is to be collected*.

Table 7 Pre-Test UUT Configuration Settings

Setting	Value	Description
Units	$^{\circ}\text{C}$	Set system temperature units to $^{\circ}\text{C}$
Emissivity	0.95	Set emissivity setting to 0.95
Reset cutout	N/A	Make sure cutout is not engaged
Scan Rate	DEF	Set scan rate to default value
Stability Limit	DEF	Set stability limit to default value

When the calibration process must collect As Found data, the following UUT configuration and control settings must remain at their current values until all As Found data has been collected.

Table 8 Pre-Test Controller/Calibration Constants Settings

Setting	Description
Integral	PID controller integration time setting
Derivative	PID controller derivative time setting
Prop Band	PID controller proportional band setting
Cal constants	All IR target calibration constants

8.7.2.3.2 Intra-Test UUT Settings

Once all necessary As Found data is collected, but before performing the alignment, the following UUT configuration and control settings must be set to the indicated values to ensure the data collection and alignment process will be performed as required.

Table 9 Intra-Test Controller Settings

Setting	Value	Description
Integral	DEF	PID controller integration time setting
Derivative	DEF	PID controller derivative time setting
Prop Band	DEF	PID controller proportional band setting

8.7.2.3.3 Post-Test UUT Settings

Once the calibration process is complete and all As Left data has been collected, the following UUT configuration and control settings must be set to the indicated values to ensure the UUT is ready for use.

Table 10 Post-Test UUT Settings

Setting	Value	Description
Cal Date	<today>	Set calibration date to “today” (only if IR target alignment performed!)
Set-point	25	Set set-point to 25°C
Scan Rate	<value>	Set scan rate to the value defined for the instrument use
Stable Limit	DEF	Set stable limit to the value defined for the instrument use
Soft Cutout	<value>	Set soft cutout to value defined for the instrument use

8.7.2.4 Manual IR target Calibration Process



NOTES: *The 418X is tested and calibrated using the tests outlined below in the order indicated. Details on performing each of the tests can be found in the subsequent section of this document.*

Many tests that use the same nominal set-points may be performed sequentially as noted. For test specifications, durations, soak times, and other detailed information, refer to the specification tables.

All temperature tests are to be performed in °C. Before starting any tests, make sure the system temperature units are set to °C.

Table 11 IR target Testing Sequence

#	Test Name	Notes
1	Radiometric Accuracy Test	As Found/Alignment data - Perform once at each point in ascending (4180) descending (4181) order
2	Radiometric Alignment	Calculate offsets using Radiometric Accuracy data
3	Radiometric Accuracy Test	As Left data – Perform once at each point in descending (4180) order

Table 12 4180 Radiometric Accuracy Test Settings and Specs - Model 4180

Set-point (Nominal) (°C)	Soak (min)	Samples	Spec (±°C)	Radiometric 2σ Limit (°C)
-15	15	100	0.400	0.100
0	15	100	0.400	0.050
50	15	100	0.500	0.050
100	15	100	0.500	0.085
120	15	100	0.550	0.100

Table 13 Radiometric Accuracy Test Settings and Specs – Model 4181

Set-point (Nominal) (°C)	Soak (min)	Samples	Spec (±°C)	Radiometric 2σ Limit (°C)
35	15	100	0.350	0.050
100	15	100	0.500	0.095
200	15	100	0.70	0.165
350	15	100	1.200	0.280
500	15	100	1.600	0.400

8.7.2.4.1 Radiometric Accuracy Test

1. Ensure that the UUT has stabilized at the first set-point prior to starting the Radiometric Accuracy Test.
2. The Radiometric Accuracy Test requires the use of one radiometric reference standard which must be aligned at the center of the UUT’s black body target. Align the UUT properly with the radiometric reference standard.
3. The Radiometric Accuracy Test is used to collect As Found, Alignment, and As Left data. For the Radiometric Accuracy Test, radiance measurements (S) are taken from the radiometric reference standard. These measurements shall be recorded. The apparent temperature (T_{app}) is calculated from the radiance measurements using the following formula:

$$T_{app} = AS^{1/2} + BS^{3/2} + CS^2 + D\ln(S) + T_0$$

where:

S = readout radiance measurement from radiometric reference

A, B, C, D, T₀ = Calibration constants from radiometric reference

4. For nominal set-points, soak times, number of measurements, specs, and other settings, refer to the Table 12 on opposite page and Table 13 on opposite page. Radiometric Accuracy Test radiance measurements shall be taken at a 10 second interval.
5. The apparent temperature 2σ is calculated from the radiance measurements using the following formulas:

$$\frac{\partial T_{app}}{\partial S} = \frac{1}{2} AS^{-\frac{1}{2}} + \frac{3}{2} BS^{\frac{1}{2}} + 2CS + \frac{D}{S}$$

$$2\sigma T_{APP} = \frac{\partial T_{APP}}{\partial S} \times 2\sigma S$$

where:

S = readout radiance measurement from radiometric reference

A, B, C, D = Calibration constants from radiometric reference



NOTE: For all UUTs, perform the As Found and Alignment Radiometric Accuracy Tests in ascending order starting with the coldest nominal set-point. After alignment, perform the As Left Radiometric Accuracy Tests in descending order starting with the hottest nominal set-point.

6. Set the IR target to the nominal temperature set-point and engage temperature control.
7. Monitor the instrument's stability indicator until it reports the IR target is stable.
8. Allow the instrument to soak at the set-point for 15 minutes.
9. Take readout radiance measurements from the radiometric reference standard at 10 second intervals.
10. Calculate the average and 2σ (2x standard deviation) of the measurements. Record the results.
11. Calculate the average and 2σ apparent temperature using the formula provided.
12. Calculate the apparent temperature error using the formula indicated below. Record this result.
error = average – nominal
13. Compare the error with the spec to determine the pass/fail status. Record the result.
14. Compare the apparent temperature 2σ result with the 2σ spec to determine the pass/fail result. Record the result.

Table 14 IR target Accuracy Adjustment Specifications

Parameter Name	Offset Spec		Corresponding Temperature For 4180 (°C)	Corresponding Temperature for 4181 (°C)
	Nominal	*Variance (±)		
IR CAL 1	0.000	9.999	-15	-15
IR CAL 2	0.000	9.999	50	200
IR CAL 3	0.000	9.999	120	500

8.7.2.4.2 Radiometric Accuracy Alignment

1. The Radiometric Accuracy Alignment process calculates new offsets to be programmed into the instrument to correct for temperature errors over the entire range of the IR target.



NOTE: The Radiometric Accuracy Alignment process must be performed using data that was collected from As Found or Alignment Radiometric Accuracy Tests.

2. Locate the results of the As Found or Alignment Radiometric Accuracy Tests. Data at all set-points is used.
3. Using the nominal temperature set-point and the error that was calculated for each Radiometric Accuracy Test, calculate a best fit least-squares second-order polynomial that characterizes the errors measured at each nominal temperature set-point.
4. Using this polynomial, generate a temperature vs. error table that includes the temperature set-points that correspond to each of the accuracy calibration offset parameters.
5. Calculate the new value for each of the accuracy calibration offset parameters using the previous (current) offset value and the calculated error at the corresponding set-point temperature using the formula below.

$$\text{IR CAL}_{n_{\text{new}}} = \text{IR CAL}_{n_{\text{previous}}} - \text{error}_{\text{set-point}}$$

6. Enter the new offset values into the instrument.
7. Allow the instrument to soak/equilibrate for at least 15 minutes after entering the new offset values before taking any measurements.
8. Proceed with taking As Left data.

9 Maintenance

The instrument has been designed with the utmost care. Ease of operation and simplicity of maintenance have been a central theme in the product development. Therefore, with proper care the instrument should require very little maintenance. Avoid operating the instrument in an oily, wet, dirty, or dusty environment.

Ice will build up on the target surface over a period of time, see see Section 3.4.3 Removing Ice Buildup on the Target on page 17.

If the outside of the instrument becomes soiled, it may be wiped clean with a damp cloth and mild detergent. **DO NOT** use harsh chemicals to clean the instrument, which may damage the paint. **DO NOT** wipe the front plate (target).

It is important to keep the target surface of the instrument clean and clear of any foreign matter. Always utilize the target cover when the instrument is not in use and during transport.

The instrument should be handled with care. Avoid knocking or dropping the instrument.

If a hazardous material is spilled on or inside the instrument, the user is responsible for taking the appropriate decontamination steps as outlined by the National Safety Council with respect to the material.

If the mains supply cord becomes damaged, replace it with a cord with the appropriate gauge wire for the current of the instrument. If there are any questions, contact an Authorized Service Center (see Section 1.6 Authorized Service Centers on page 7) for more information.

Before using any cleaning or decontamination method except those recommended by Hart, users should check with an Authorized Service Center (see Section 1.6 Authorized Service Centers on page 7) to be sure that the proposed method does not damage the equipment.

If the instrument is used in a manner not in accordance with the equipment design, the operation of the instrument may be impaired or safety hazards may arise.

10 Troubleshooting

This section contains information on troubleshooting.

In the event that the Precision IR Calibrator appears to function abnormally, this section may help to find and solve the problem. Several possible problem conditions are described along with likely causes and solutions. If a problem arises, please read this section carefully and attempt to understand and solve the problem. If the IR Calibrator seems faulty or the problem cannot otherwise be solved, contact an Authorized Service Center for assistance. Be sure to have the instrument model number, serial number, and voltage available.

Table 15 Troubleshooting, problems, causes and solutions

Problem	Causes and Solutions
The instrument does not power up	Check the fuses. If a fuse blows, it may be due to a power surge or a component failure. Replace the fuse once. DO NOT replace the fuse with one of a higher current rating. Always replace the fuse with one of the same rating, voltage, and type. If the fuse blows a second time, it is likely caused by failure of a component part. Power Cord. Check that the power cord is plugged in and connected to the instrument. AC Mains Power. Insure the circuit supplying power to the instrument is on.
The display is blank The instrument powers up: 4180 – fan turns on, 4181 – the power relay clicks, but the display remains blank	Contrast. Check the screen contrast. Toggle the down arrow key to see if the screen contrast lightens. If the contrast is not the issue, contact an Authorized Customer Service Center.
The instrument heats slowly	Scan Rate. Check the Scan Rate settings. The Scan Rate may be set with too low a rate per minute for the current application.
If the display shows an abnormal temperature	The sensor is disconnected, open or shorted. Please contact a Service Center for further instructions.
If the display shows cutout	Cutout. If the IR Calibrator exceeds the temperature set in the soft cutout menu or if it exceeds the maximum operating temperature of the instrument, a cutout condition occurs. If this happens, the unit enters cutout mode and will not actively heat or cool until the user issues this command to clear the cutout or resets the instrument using the SET PT. key to clear the cutout mode and activate the instrument. Reset. The software cutout may need to be adjusted for the application. Check and adjust the cutout setting by entering CUTOUT menu: MENUITEMPSETUPICUTOUT.
Apparent Temperature is not the displayed temperature OR Incorrect temperature reading	Operating Parameters. Insure that all operating parameters for the IR Calibrator match the Report of Certification that was sent with the instrument. Electrical Interference. Look for sources of electrical interference, such as motors, welders, or RF generating equipment nearby, or ground loops.

